

A trade journal quarterly publication since 1999

Steel Market Info

THE MAGAZINE DEVOTED TO STAINLESS STEEL AND ITS APPLICATIONS **स्टील** **मार्केट** **इन्फो**

The **POWER** of Indian Stainless Steel **2015**



VOLUME
57
YEAR 15

Manufacturer
Exporter
Retailer
January 2015

&
INDINOX2015
Exhibitor Directory

**MANUFACTURER & EXPORTER of PREMIUM QUALITY
STAINLESS STEEL SHEETS, BLANKS & CIRCLES (Patta-Patti)**



Thickness : 0.50mm TO 5.00mm
Width : upto 800mm

Surface Finishes : 2D, 2B (Skin Pass)
Hardness : Full, Half, Quarter, Soft as per requirement

**In-house Blanking & Shearing Services
for Precision and Quality Control**

**Suppliers to leading manufacturers of Stainless
Steel Sinks, Stoves/Cook-tops, Cutlery, Catering
Equipment, Clamps and Designer Show-Pieces**

**MOHENDER KATHURIA
AMAN KATHURIA**

B. G. STEELS PVT. LTD.

Manufacturers of Stainless Steel Precision Material

SP 313/C, RIICO Industrial Area Phase - I, BHIWADI, Distt. ALWAR (Rajasthan)
Tel.: 0-1493-512534, 0-1493-512134 • E-mail: info@bgsteels.com
Cell: 09810108130, 09310108130, 09891458458

Boskina® INDUSTRIES

Sameer Shah - 98200 77884



Reg. Office: 40/1, Mahaveer Market, 2nd Panjrapole Lane, Mumbai - 400 004. Works: Gala NO. 10/12, Anand Ind. Estate, Navghar Road, Bhayandar (E) 401 105.
Tel.: +91-22-2817 4545 / 4646 / 4747 / 39317788. Fax: +91-22-2816 6363. Email: boskinaindustries@gmail.com, exports@boskina.in, shah_sameer16@yahoo.co.in,
Website: www.boskina.in

Steelcraft[®]
by rajlaxmi

www.steelcraftutensils.com



Experience the 
ROYAL DINING
 at your PALACE

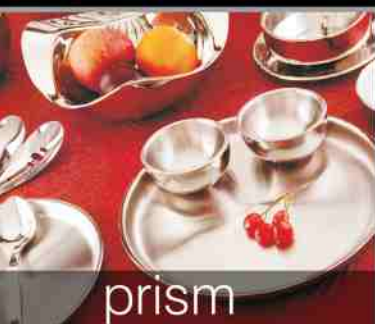

prism



bliss

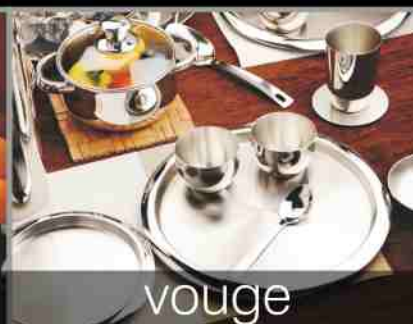

vouge



nirvana

RAJLAXMI INDUSTRIES

E-93. M.I.A., II Phase Basni, Jodhpur, Rajasthan - 342005 INDIA • Ph.: +91-291-2741452, 2744452
Web: www.rajlaxmisteels.com • E-mail: info@steelcraftutensils.com
For Corporate Enquiry Call: +91-97 999 63 000



BUILDING TRUST SINCE 1983

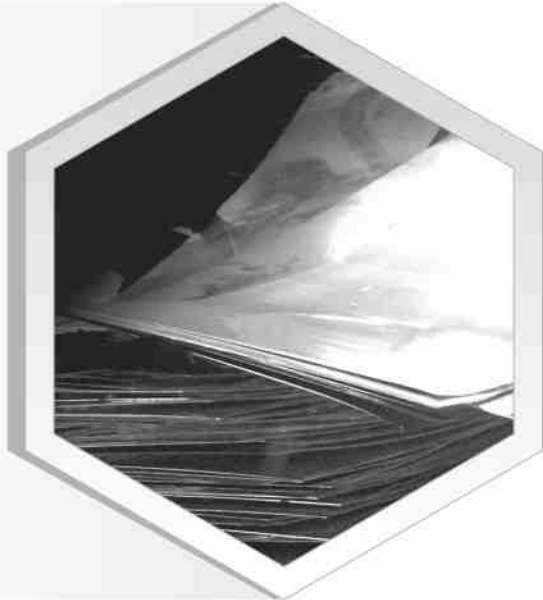

- Superior quality
- Spotless Surface Finish
- Minimal Gauge Variation
- Efficient Delivery Channel
- Competitive price
- Skilled and experienced technocrats

STAINLESS STEEL SHEETS



We manufacture Cold Rolled Stainless Steel Sheets in following Specifications :

Grades	J7, J6, J5, J4, 304, 316, 400 Series	-
Sheet length	1500 to 3000mm	[(+ -) 3%]
Sheet Width	uptil 535mm	[(+ -) 3%]
Thickness	0.5 to 10mm	[(+ -) 3%]

Surface Finishes : 2D, 2B (Skin Pass)

Hardness : Full, Half, Quarter, Soft as per requirement

In-house Blanking & Shearing Services
for precision and quality control

APPLICATIONS

HOUSEWARE: Cutlery, Sinks, Saucepans, Washing Machine Drums, Microwave Oven Liners, Switch Gears, Razor Blades.

ARCHITECTURAL: Hinges, Door Handle, L-Drop, Locks, Cladding, Handrails, Door and Window Fittings, Street Furniture, Structural Sections.

TRANSPORT: Exhaust Systems, Car Trim/Grilles, Road Tankers, Ship Containers, Ships Chemical Tankers, Refuse Vehicles.

CHEMICAL/PHARMACEUTICAL: Pressure Vessels, Process Piping.

OIL AND GAS: Platform Accommodation, Cable Trays.

MEDICAL: Surgical Instruments, Surgical Implants, MRI Scanners.

FOOD AND DRINK: Catering Equipment, Brewing, Distilling, Food Processing.

WATER: Water and Sewage Treatment, Water Tubing, Hot Water Tanks.

GENERAL: Springs, Fasteners (Bolts, Nuts and Washers), Wire.



GROVER

S.S. SHEETS

Specialist in **1mm** Thickness to **7mm** Thickness
Cold Rolled Patta
Also Deals in Stainless Steel 400 Series

Providing _____●
stainless sheets to _____●
● _____ *stain'less* people

Ashok Grover : 09811026665

Aman Grover : 09811243404

GROVER STAINLESS PRIVATE LIMITED

E-14 S.M.A Industrial Area, G.T Karnal Road, Delhi-110033
Tel. 91-11-27694440,1,2,3 Email : agsteels@hotmail.com, groverstainless@hotmail.com

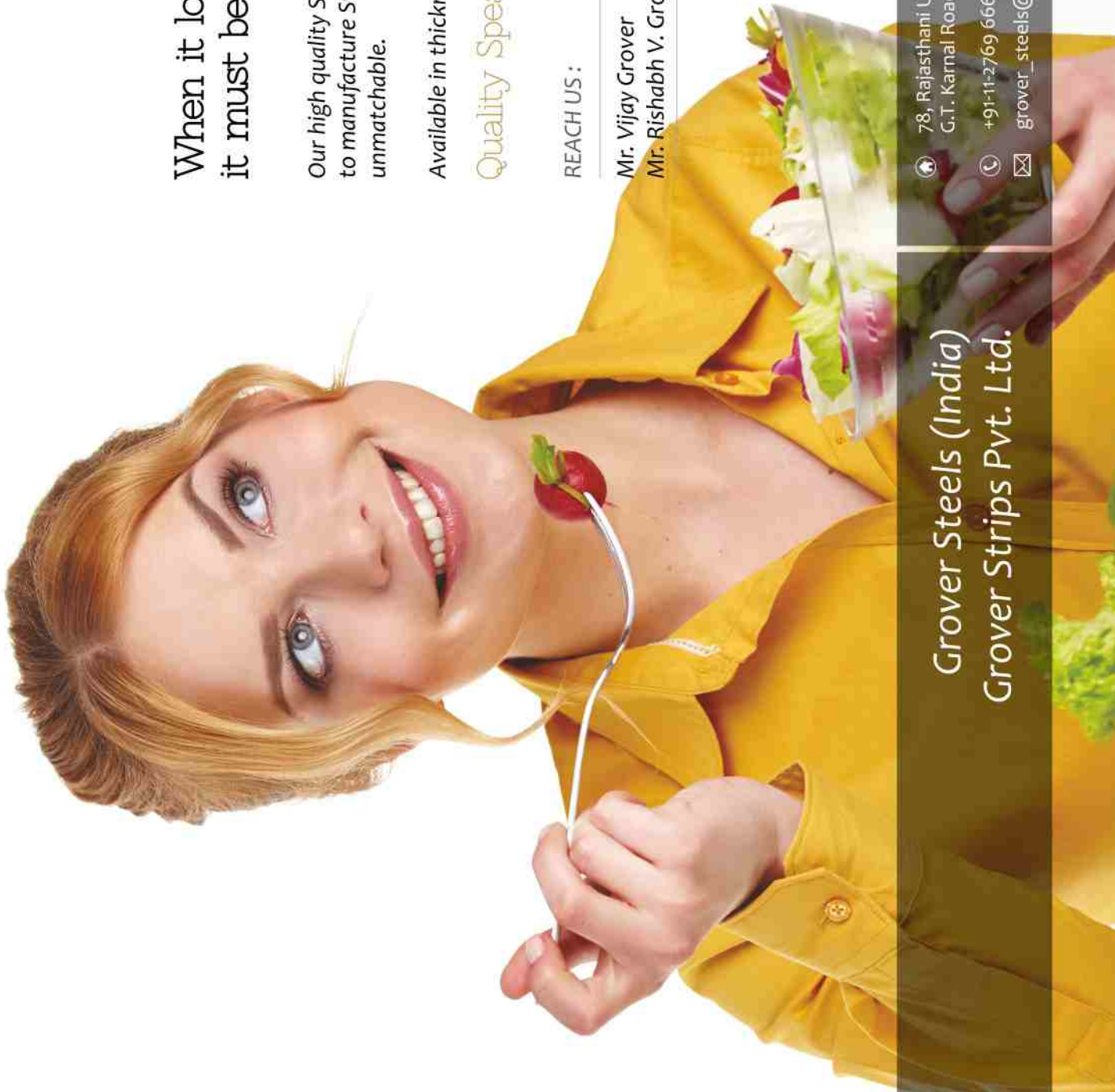

When it looks so good,
it must be Grover Steel.

Our high quality Stainless Steel Patti is specially developed
to manufacture Stylish Cutlery & Kitchen Tools. It's surface finish is
unmatchable.

Available in thickness from 1 mm to 7 mm.

Quality Speaks Itself.

REACH US :

Mr. Vijay Grover : 981166065

Mr. Rishabh V. Grover : 9811066649

Grover Steels (India)
Grover Strips Pvt. Ltd.

📍 78, Rajasthani Udyog Nagar,
G.T. Karnal Road, New Delhi-33

📞 +91-11-2769 6665, +91-11-27692399

✉ grover_steels@yahoo.co.in



BHALARIA

if you can draw it, we can make it

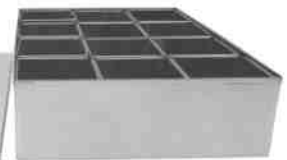

WHY BHALARIA?

- Advantage of wide and varied machineries and capability for different product range operations
- Consistent Quality
- 6500 Product Range to Offer, 500 OEM Products
- Service - small orders are also catered
- 100 products in one container can be shipped
- 9 times Export Excellence Award Winner from Govt.
- 14 times Design Award Winner
- Relationship Management, Value Partnership The Thoughts - of Bhalaria Team

BHALARIA METAL CRAFT PVT. LTD.

Bhalaria Rd., Opp. Hindu Shmashan, Bhayander (W), Mumbai, Dist. Thane, Maharashtra 401 101, India Tel : (91-22) 2819 8234, 2819 8226, Fax : (91-22) 2819 8227, 2625 6526, E-mail : sale@bhalariametal.com, exports@bhalariametal.com, Website : www.bhalaria.com, www.bhalariametal.com



CHOICE OF CONNOISSEURS



www.lilysteel.com



Casseroles
Dinner Sets
Kitchen sets
Lemon Sets
Copper Steel & other Jugs
Extra Deep Bhojan Thal
Thali Sets

Vijay Vallabh Metals Sahu Street, Mandi chowk, Moradabad-244 001 Tel : 99971 44144, 99972 44144 Email : vijayvallabhmetals@yahoo.co.in



advertisements

2	B. G. Steels
3	Boskina Impex
4	Rajlaxmi Industries
5	Jay Kay Enterprises
6	Grover Stainless Pvt. Ltd.
7	Grover Steels (India)
8	Bhalaria Metal Craft Pvt. Ltd.
9	Vijay Vallabh Metals
12	Bee Gee Impex (Pogo)
13	Shree Shakti Enterprises Pvt Ltd
14-15	Sagar International
30	Metal Bulletin
31	Household Expo
32	IHA Fair
33	Houseware Expo
34	Ideal Home Fair
35	EPCH
36	HKTDC Fair
37	Giftext Japan
38	House & Gift Fair
39	Sculpture Book
40	Shreepal Overseas
45	KC Metal Industries
46	Shiv Steel Corporation
47	Toral Stainless Steel (VARA brothers)
48	Topaz Industries
49	Shree Balaji Metal Industries
51	Akjay International LLC
52	Aristo Steel Pvt. Ltd.
53	Keyur Kitchenware
59	M.A. Enterprises
60-61	Komal Trading Corporation
66	Sam International
67	Palmline Plastics Pvt. Ltd.
74	Kad Steel Rolling Mills
75	Mercury Industries
75	Gayatri Metal Works
84	Mehta Enterprises
85	SRM Group
86	Ratna Home Product Pvt. Ltd.
108	Nav-Tech Industries
112-113	Sharma Machine Tools
114	Taj Home Craft Company
115	Graphic 9
116	Meera Exclusive
117	Bhalaria Metal Craft Pvt. Ltd.
118	Mili Steel Pvt Ltd
119	Jagdamba Cutlery Pvt Ltd
120	Indian S.S. Houseware Show 2015

contents

16	Cover Story - History of Indian Stainless Steel
29	A brief intro of Mr. N.C. Mathur
41	Stainless Steel Link launched
42	ISSDA celebrates its 25 Year Anniversary.
50	Spinning Process of Utensils
54	Star Light, Star Bright
56	Cold Forming is shaping the future for Stainless
58	The art of recycling
62	An ever changing masterpiece
64	its kind of stainless steel modular Toilets
68	A Pioneer and Leader in....
70	The need of the hour
72	Our Trade Mark....
73	Dragon the legend comes to life
76	Stately Slide
77	Stainless Steel Deep Drawing
78-83	News
87-107	Indinox 2015 - Exhibitor Directory
108	Multimillionaire Gifts luxury flats
109	470li Stainless Steel Hood



विश्व विकास में स्टेनलैस स्टील का महत्वपूर्ण स्थान

प्रिय उद्यमी पाठकगण,

आपके साथ चलते चलते हम पन्द्रहवें वर्ष में प्रवेश कर चुके हैं और जनवरी 2015 का संस्करण अब आपके हाथों में है। इस अंक के साथ हम आपके सभी नये और प्रारम्भ से जुड़े उद्यमी पाठकों को नववर्ष की शुभकामनायें व निरंतर साथ जुड़ने के लिए धन्यवाद प्रस्तुत करते हैं।

इस संस्करण के ध्यैय की ओर बढ़ते हुए और इतने समय से आपके सम्पर्क में होते हुए हमने सदैव स्टेनलैस स्टील के उत्पाद, निर्माण व उपयोग के प्रसंग पर उपलब्ध ज्ञान के प्रचार व प्रसार की ही बात की है। जोकि वास्तव में एक विलक्षण धातु है और बड़ी आसानी से पुरानी धातुओं को अपने मार्ग से हटाता जा रहा है। आज स्थिति यह है कि सभी विकसित राष्ट्र अमेरिका, यूरोपिय देश, चीन, जापान, फ्रांस, भारत या यूं कहें पूरा विश्व स्टेनलैस स्टील के उपयोग के लिए अपनी आतुरता दर्शा रहा है, और इस धातु का विज्ञान तथा तकनीकी अभिलेखों ने जिस पर हमारी आधुनिक सभ्यता खड़ी है ने भी दृढ़ता से सराहा है।

आज स्टेनलैस स्टील उत्पादक व स्टेनलैस स्टील एप्लीकेशनों पर आश्रित समुदाय चाहे फेब्रीकेटर हो उत्पादक हो, आर्कीटेक्ट हो या फिर डिजाईनर सभी अनुभव कर रहे हैं की स्टेनलैस स्टील के बारे में उपलब्ध ज्ञान का प्रचार-प्रसार अन्तिम उपभोक्ता तक पहुंचाया जाए और सिर्फ यही परिश्रम स्टेनलैस स्टील के प्रयोग, उपयोग व खपत को बड़े पैमाने तक बढ़ाने में सहायक सिद्ध हो सकता है।

स्टेनलैस स्टील ने सभी धातुओं और एलॉयज को बेदखल कर दिया है और आज उसके सामने कोई स्पर्धा करने वाला मौजूद नहीं है। स्टेनलैस स्टील ने आधुनिक विकास में लगे धुरन्धरों, आधुनिक सभ्यता के निर्माताओं को शक्ति सम्पन्न बना दिया है और मनुष्य उसके रूप, गुण, लक्षण व विशेषताओं पर आसक्त हो चुके हैं। अब सिद्ध हो चुका है कि स्टेनलैस स्टील ही एक मात्र धातु है जो अन्य धातुओं के समक्ष आ रही है। मुसीबतों से छुटकारा दिलाने में और जिन कठिनाओं ने अन्य धातुओं को नकारा साबित कर दिया है हमारा तो यह मानना है कि स्टेनलैस स्टील आधुनिक सभ्यता का कवच है।

स्टील मार्केट इन्फो प्रचार-प्रसार की बी-2-बी व्यवसाय की एग्जिबिशन की प्रतिवर्ष की श्रृंखला में अपना 5वां स्टेनलैस स्टील हाउसवेयर शो 2015 आगामी 12-14 जुलाई को चैन्नई में अयोजन करने जा रहा है। आप भी अपने उत्पादनों का स्टॉल लेकर प्रदर्शन कर एक नई पहचान बना कर, व्यवसाय को गति प्रदान कर सकते हैं या विजिट कर निर्माताओं से सीधा सम्पर्क कर भी व्यापार को बढ़ा सकते हैं। इस अंक में भारत के स्टेनलैस स्टील उद्योग के अतीत वर्तमान व भविष्य की संक्षिप्त जानकारी दी गई, जो कि आपको भारत के स्टेनलैस स्टील के इतिहास का संक्षिप्त जानकारी प्रदान करेगा। हमेशा की तरह हमारे प्रकाशन पर आपकी प्रतिक्रियाओं का स्वागत है।

एकबार पुनः नववर्ष की शुभकामनाओं के साथ।

Importance of Stainless Steel for development

With season's greetings now "Steel Market Info" has completed 14th years of dedication to development of stainless steel and its applications through regular print editions and exhibitions. This is the first issue of 15th years for the month of January 2015. We always stand with your kind support in stainless steel developments through our publication. Stainless Steel take place of aluminium, copper, bronze and other materials in lot of segments. America, Europe, China, Japan, France and India also like stainless Steel very much. Presently Stainless steel becomes an important part of human life. Uses of Stainless Steel in large quantity against other materials throughout the world.

In this connection Steel Market Info is going to organize B2B business exhibition's 5th session from 12-14 July 2015 at Chennai. All member, producer, importers, exporters, traders may also take a part in 5th Stainless Steel Houseware Show at Chennai for expansion of your business relation. This edition is fulfil with past, present and future details regarding Stainless Steel. Now we can say this is a historical edition of Stainless Steel. We are awaiting your valuable suggestions.

Once again seasons greeting to all.

R. Choudhary



R. L. Choudhary
Editor - in - Chief & Publisher

Editor Desk

Year
15

Volume
57

Asst. Editor
Khushboo Choudhary

Advisor
Hitendra Bhalaria

Published at
2nd Floor, Nirmal Tower,
Chopasni Road, Jodhpur - 342003
(Rajasthan) INDIA

Office Tel
+91-291-2441514

Fax:
+91-291-2632533

Cell:
+91-9314713809

E-mail
info@steelmarketinfo.com

Website
www.steelmarketinfo.com

Layout Design
M. Asad

Cover Page Photograph
Steel Market Info

Printed by
M/s. Daga Printers, Inside Nagori
Gate, Jodhpur Tel: 0291-2548513

DISCLAIMER

Material Presented in this publication has been prepared for general information of the reader and in some instances is reproduced from information supplied by various agencies whilst all care is taken in the compilation of this publication neither steel market info nor any of its members, agents or servants accept responsibility for the contents.

पोगो
किचनवेयर
कुद् तो बात है...



Chef SERIES
CAPSULATED
SANDWITCH BOTTOM



Casserole



Kadai



Fry Pan



Bellina Casserole



Myra Cutlery Set



Marvel 5 Pc Set



Spice Jar Set
(Design Patent)

BEE GEE IMPEX

428/1, ANAND PARBAT INDL AREA, DELHI
For Distributor Enquiry: 09811090955

*First time in India
introducing 5ly cookware*

Best
Cookware
Awards



5ly COOK N SERVE



5ly FRY PAN



5ly SAUCE PAN



5ly KARAHI



ASSEMBLED WITH SPECIAL SILICON HANDLES FOR EASY GRIP AND HEAT RESISTANCE

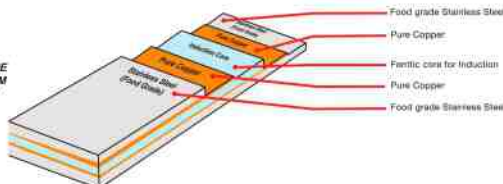
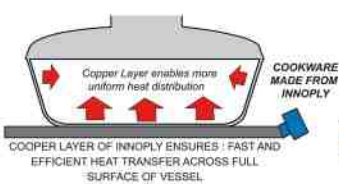

Shweta Tiwari
(Brand Ambassador)

Not only I recommend the product because I am The Brand Ambassador for the company, but the product is an excellent combination of quality and value

SHREE SHAKTI ENTERPRISES PVT.LTD.

Plot No.72, Phase-IV, Sector-57, HSIIDC, Kundli, District Sonapat, Haryana - 131028

Phone:0130-2219960/61/62 Telefax: 0130-2219963 Fax: 0091-130-2219964

Email: info@pnbutensils.com

FOR OEM/CORPORATE ENQUIRY : 9311830050

FOR DISTRIBUTION & EXPORTS : 9311010996



Let's Choose Things Better



Since 1980



Sagar Metal Industries

Add - Jato gali, Amroha gate, Moradabad, (U.P.)

Tel - 0591-2325896, 2317912, 2430477 Call - +91-9412236335, 91-9412806113, 91-9412246335

हर गृहणी की शान, रसोई की जान



Our Speciality in Stainless Steel Dinner Set...

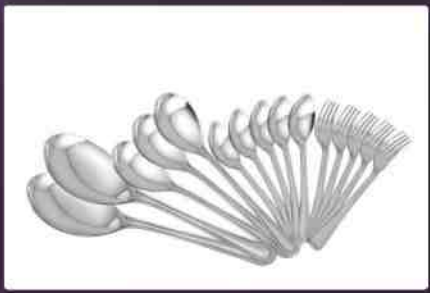

100+ Years of Stainless Steel and its Development in India

- By **Mr. N C Mathur** President ISSDA



Stainless steel was actually discovered to get rid of the rusting formed by moisture on the pipe of the guns, but very frequently it was used to manufacture medical equipments. Grade 304-316 of the stainless steel was used for the manufacturing of surgical equipments. Stainless steel was introduced in India in the same form. It was sent from Japan. The Japanese company Nipone was the first largest company to produce stainless steel. In India, aluminium, copper and bronze utensils were being produced in great quantity. A representative group from Japan visited India and gave training for making surgical equipments to 2-3 units in Chennai and made an agreement with the Indian Government that Japan would

provide grade 304 stainless steel sheets with little to no profit for the manufacturing of surgical equipments.

The government lifted the import duty on terms that only the license holders for manufacturing surgical equipments can import the sheets and they should be wholly used for the purpose of manufacturing surgical equipments only. Stainless steel was majorly used for manufacturing surgical equipments but the manufacturers came up with an idea to use it to make bowls, plates and glasses. But due to government terms the stainless steel can only be used for manufacturing surgical equipments only but still the manufacturing of stainless steel

utensils took place illegally. The stainless steel utensils were not accepted easily but later on they became useful. Indian utensil manufacturing company Devilal managed to convince the government to use the imported stainless steel sheets for manufacturing utensils and they were successful.

Devilal company started importing stainless steel sheets from the Japanese vendor Nipone and started the production of utensils in Mumbai. Later on, the surgical equipment unit also started manufacturing stainless steel utensils. Many units in Chennai now make stainless steel utensils in the name of surgical equipments. This is how stainless steel arrived in India.

A brief timeline of the evolution of stainless steel around the world

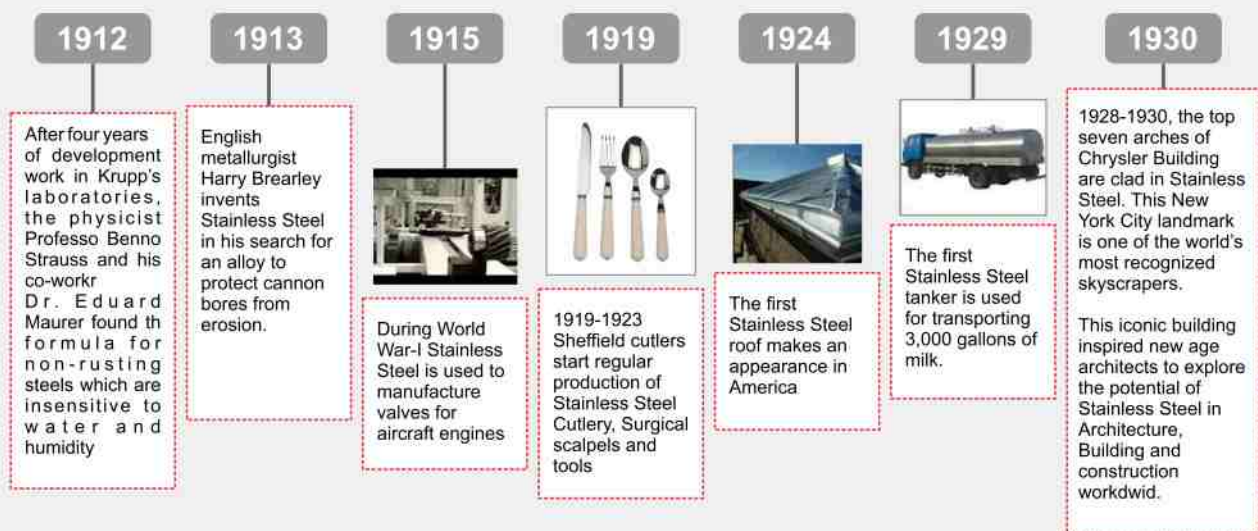

Fig. # 1

Evolution of Stainless Steel and its initial growth around the World

It was more than a hundred years ago that stainless steel as a material was discovered and commercially produced. It was a culmination of the efforts put by numerous scientists who researched with chromium alloyed steels. But it was not until the early decades of the 1900s that the first stainless steel was patented and manufactured.

Nothing could have started till in 1797 Nicolas-Louis Vauquelin discovered chromium. Although some progress was made with Chromium alloyed steels but only between 1904- 1911 Leon Alexandre Guillet published a research into iron, chromium and nickel alloys that today would be classed as stainless steel. Later in 1910-1911 Philipp Monnartz and William Borchers obtained a German patent for stainless steel. Monnartz published a Study of Iron-Chromium Alloys with Special

Consideration of their Resistance to Acids. He was the first to explain that stainless steel requires at least 12% chromium and a controlled amount of carbon.

The actual birth of Stainless steel has been attributed to following researchers. In 1912, while working for Krupp, Eduard Maurer and Benno Strauss are granted patents on two chromium-nickel stainless steels. The first alloy was a martensitic grade, while the second was an austenitic grade. In 1913, Harry Brearley discovered martensitic chromium stainless steel while seeking a corrosion-resistant alloy for gun barrels. Later he casted the first commercial martensitic chromium stainless steel. In 1915 Brearley obtains Canadian, French and US patents.

Later during 1919-1923 Sheffield cutlery started regular production of stainless steel cutlery, surgical scalpels and tools. Early stainless tableware

such as dishes and bowls also started to appear at this time.

From small beginnings a hundred years ago, stainless steel has grown to be an integral part of our lives. Utilized primarily for its corrosion resistance, stainless steel is also found in applications where strength, innovation and aesthetics are important.

The production volumes of stainless steels started picking up only in 1950s with introduction of hot and cold rolling facilities. Along with the increase in production a number of grades suiting to various environment and applications were also developed later classified into austenitic, ferritic, martensitic, duplex and PH grades. Each category has its unique characteristics associated with property of corrosion resistance. Today the modern stainless steel making facilities are capable to produce highest quality grades of stainless steel for applications in most stringent conditions.

A brief timeline of the evolution of stainless steel around the world

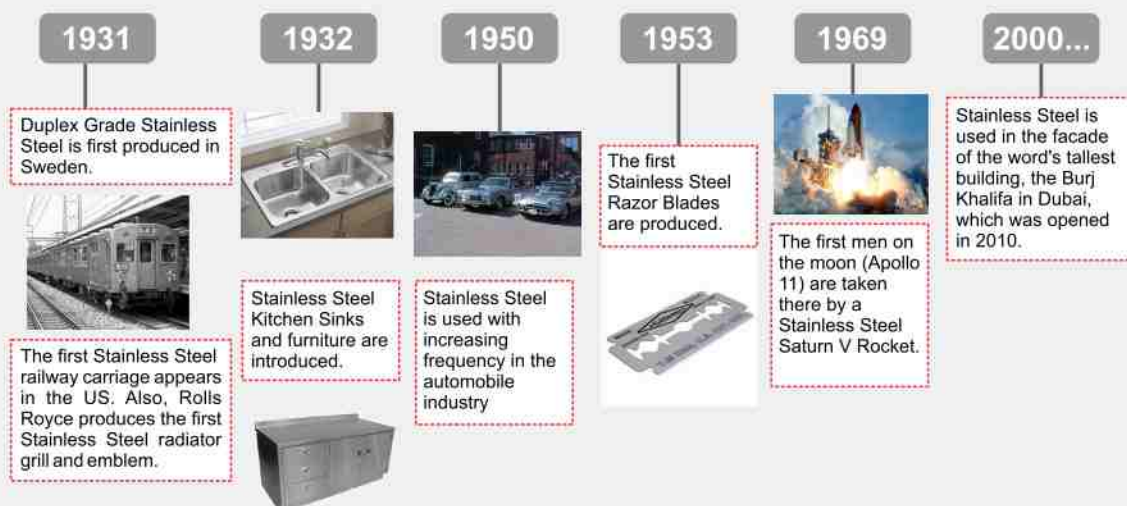

Fig. # 1

Overview of Stainless Steel Making Process

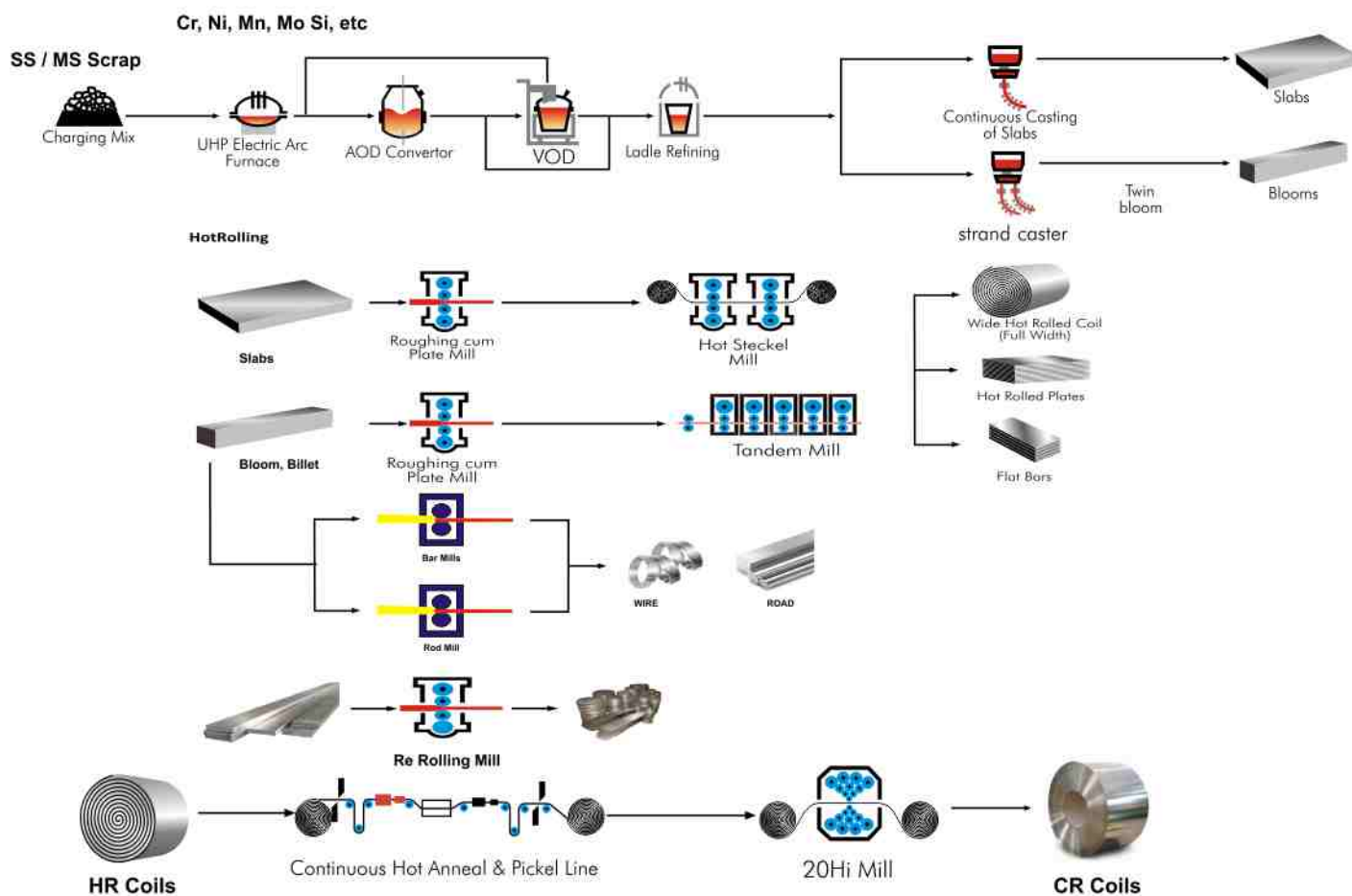

Fig. # 2

Initial Growth of Stainless Steel Industry in India

Though stainless steels were initially developed in the first quarter of last century, it was just four decades ago when stainless steel first production started in India and was primarily getting used for pots and pans in kitchen with some exception in engineering use. Till 1978, the production of stainless steel in the country was nil and most of the requirements were met through imports only. It was in 1978, ASP & VISL (Both a part of SAIL now) started producing plates, rounds and billets taking country domestic consumption to 18000 MT per

annum. Production picked up only in 1980s when new producers Bihar Alloy Steel and Jindal Strips (JSL now), G.M. Mittal (Rathi Alloys) entered into the business and started flat bar (called patta now) production suitable for re-rolling to sheets used for utensil industry. Availability of indigenously produced flats accentuated the emergence of new facilities for re rolling near Jagadhari, Jodhpur, Delhi and Ahmedabad. A small growth in domestic production started to get noticed which reach to 50,000 MT per Annum. Still the lack of indigenous cold rolling facilities to produce wider coils restricted the use of stainless steel to kitchen utensils only. It was only

in 1985 when SAIL (salem) plant started the first cold rolling unit in the country. The production touched 102,000 MT per annum and meanwhile growing demand for the use of stainless steel for utensils allowed to bloom and spread the 'patta' industry in other regions of the country specially in the state of Gujarat and Maharashtra.

During 1990 nickel prices increased sharply and it touched to 18000 US\$/MT and on the top of that there was a 55% import duty levied by government of India at that time. India being fully dependent on import on nickel and nickel still being an important element, since most of the production was in 304 grade stainless steel,

Historical Timeline of Indian Stainless Steel Growth

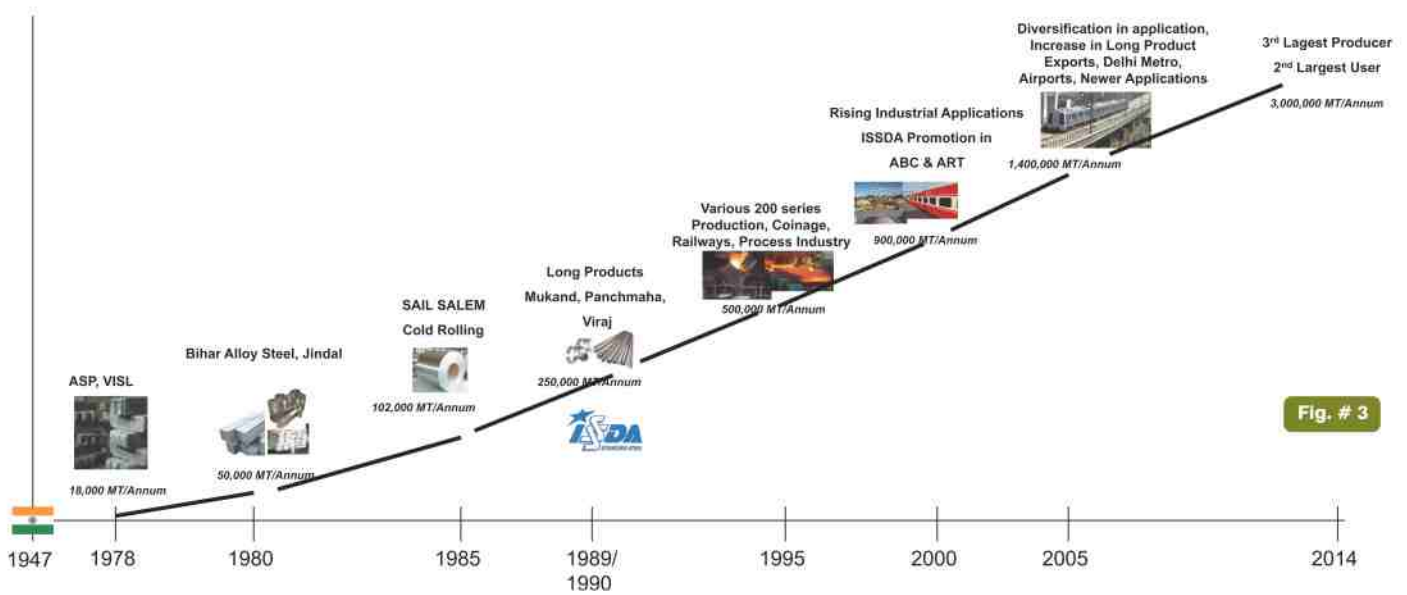

Fig. # 3

it was almost impossible to continue the growth of stainless steel in the country.

Meanwhile introduction of new technologies for processing stainless steels was coming up for faster and quality production of stainless steel all over the world. Upto mid 60's, the

stainless steels were manufactured mostly by Electric Arc Furnace – Ingot Casting - Slabbing and hot rolled to coil/sheets in hot strip/plate-sheet mills. The advent of technologies of AOD/VOD in 1990s allowed the Indian Producers to replace nickel with Manganese and Nitrogen still maintaining the

austenitic structure of stainless steel. Nickel price instability forced Indian producers to research and the birth of a variety of 200 series grades (low in nickel and high in Mn and Nitrogen austenitic stainless steel) took place. Till now, many new producers Mukund, Panchmahal, Facor, Viraj forayed into

History of Stainless Steel Production (tons)

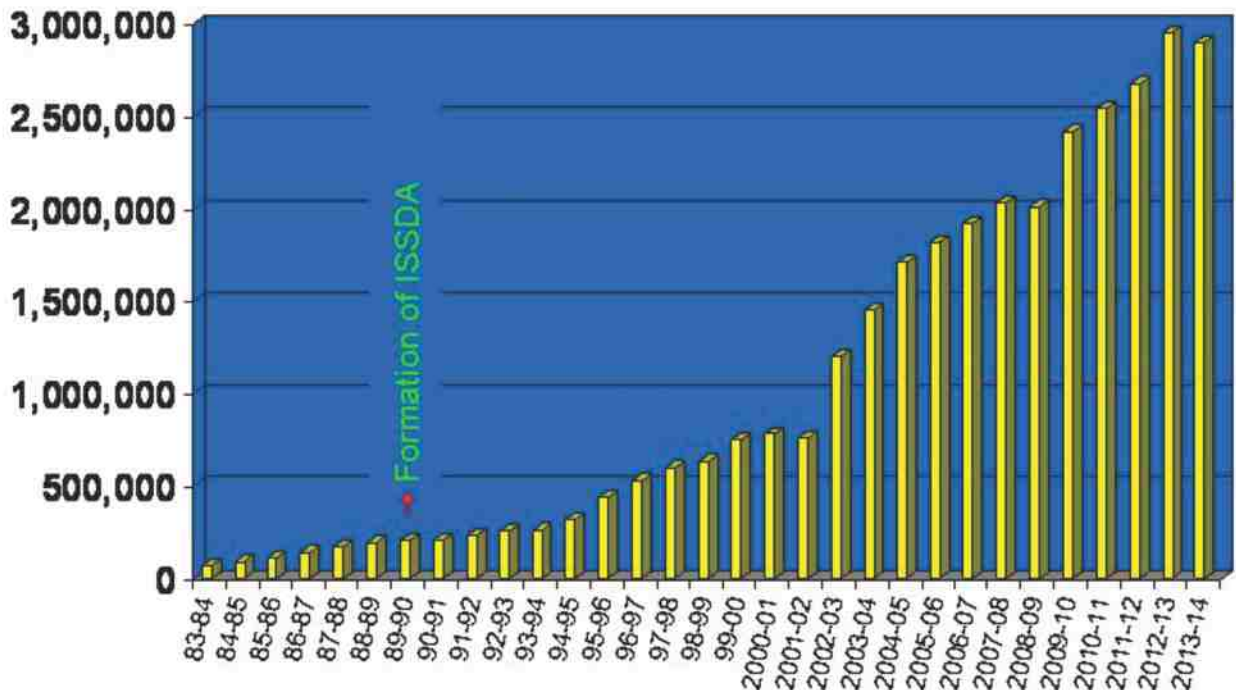

Fig. # 4

production of stainless steel long products and started their productions taking over total production of India to 250000 MT.

Although stainless steel industry was growing at a very steady rate in the country but till 1989-1990s more than 90 % of use was still in kitchen and related applications. Meanwhile, western and other developing countries started using stainless steel in more and more applications such as rail coaches, tankers for carrying liquids, pipelines for carrying oil, gas, liquids including potable water, various products for architecture, building and construction.

Initial Growth of Stainless Steel Industry in India

In 1988 representative of producers of stainless steel from India were visiting to London on invitation from Ni and Cr producers. At that point in time only four Stainless Steel Development Associations were exiting (Japan, Germany, Italy & South Africa). There has been a marked difference in the stainless

steel market development in these countries compared to others that made us think about India. We could feel that a neutral body with the sole purpose of developing a market has larger influence when compared with different organizations working in parallel to increase their market. The excitement paved the way and work started immediately after our return from the UK. Formally ISSDA was born in Nov 1989 as non-profit Organization after long debates and taking in to confidence key manufacturers (seven producers) of stainless steel. This was the time when India was producing meager quantities of stainless steel and nickel prices were hitting the roof. The challenge was tough and not much was in sight as to what could be the way to work on our mission. But we were determined to bring about a revolution in the Indian market. This was the time when the development of Cr-Mn 200 series stainless steel just started.

The main objective of ISSDA was to create awareness on the use of stainless steel and help in diversifying the usage of stainless steel in different sectors. ISSDA and its member companies

started its education and promotional activities educating everyone on how the long life on account of good corrosion resistance of stainless steel makes it suitable for many other applications since if wisely used the life cycle cost will result in long term good saving. In the last two decades, stainless steel has undergone a tremendous change in perception and production volumes in India. ISSDA has been successful in creating the awareness and changed the perception on stainless steel being seen as a material good only for kitchenware, it is now seen as a wonderful engineering material that lasts for decades and gives you value for money.

Today we see use of stainless not only in kitchen but in Indian Railways & Metro Rail Coaches, Wagons, tankers, various products for building & construction & process Industry but also in sectors such as Nuclear, Power, Oil & gas where high quality & grades that are indigenously produced, supplied and are being used.

The chart shows how in the last decade the end-use application of the stainless steel in the country evolved.

Fig. # 5

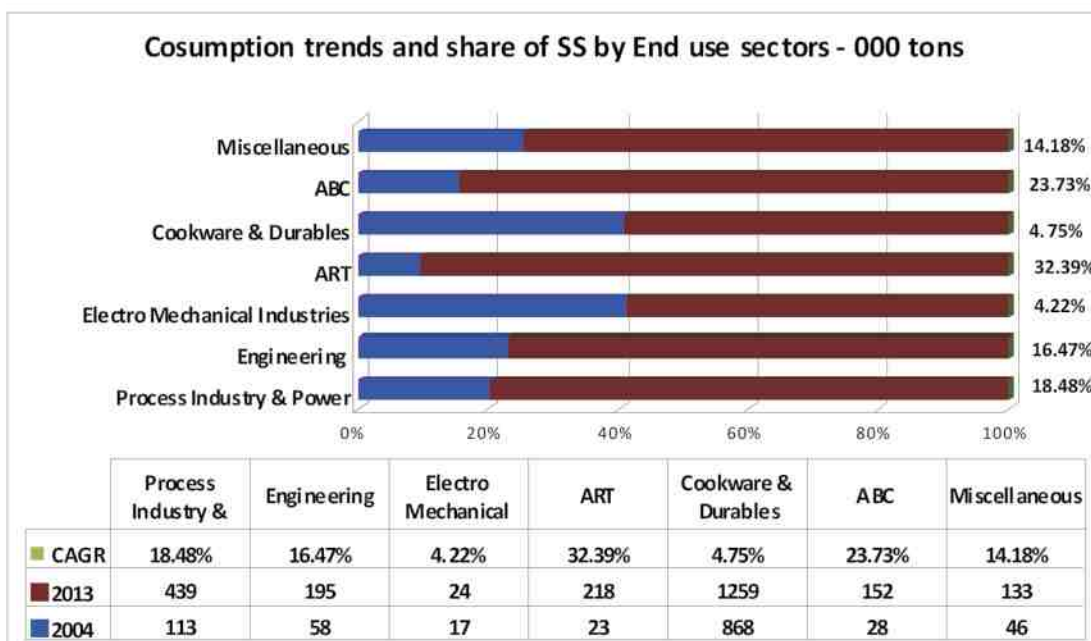

Present Production and Consumption trend of stainless steel by End Use Sector in India

The world Crude Stainless Steel production in 2013 is estimated over 38 million tons. The world production has grown at a CAGR of 5 % pa over the last 10 years. Asia has strongly emerged as both the world's largest stainless steel producer and user. Although China dominates the production of stainless steel accounting for more than 50% share of world production, India has been a part of this impressive growth with its production reaching 3 million tons in 2013 making it the 3th largest producer and 2nd largest user of stainless steel in the world. The average growth in India has recorded a CAGR of over 10 % over the last 10 years which is

more than a double the world average growth during the period.

The main Stainless Steel consuming segments can be classified into 6 to 7 broad categories e.g. Metal products, Process and Engineering industries products; Electro mechanical and electronics; Construction, Transportation and others including medical, blades, coins etc. Out of these Metal products, Process Industries and Engineering goods etc are relatively mature application areas whereas areas like construction and automobile are still evolving in the country and have great future potential for growth. Fig. 3 & Fig. 4 present the consumption patten of stainless steel flat and long products by major market sectors

respectively. Here it is worth noting that all sectors have increased their share of consumption at the expense of Metal good segment. Traditionally metal good sector including utensils and cookware has been the largest consuming sector of Stainless Steel in the country now accounting for 52% share of the overall consumption of stainless steel down from 75% in 2004. The single biggest contributor to this segment is the utensils/cookware which has grown at only 4.5% annually due to its already high level of penetration and its direct linkage with population growth. Almost 83% of the consumption of stainless steel in metal good sector is accounted by very low Nickel austenitic stainless steel flats popularly known as 'Patta'.

Consumption of Stainless Steel Flats (right) / Long (left) by End Use

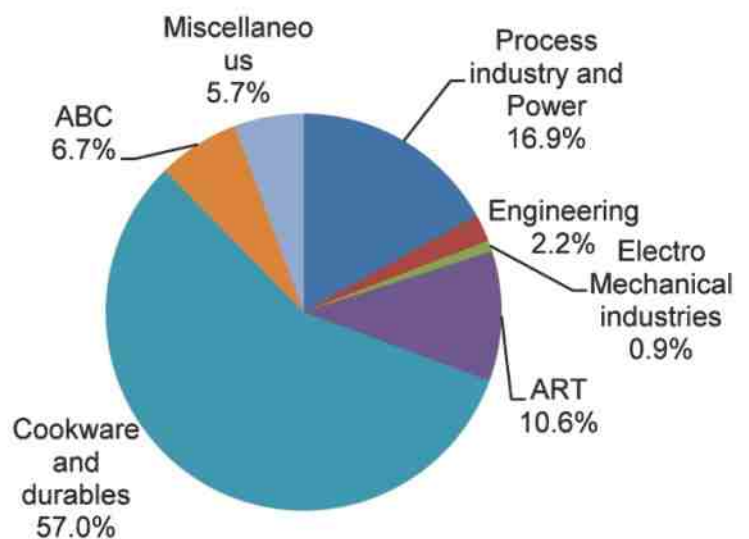
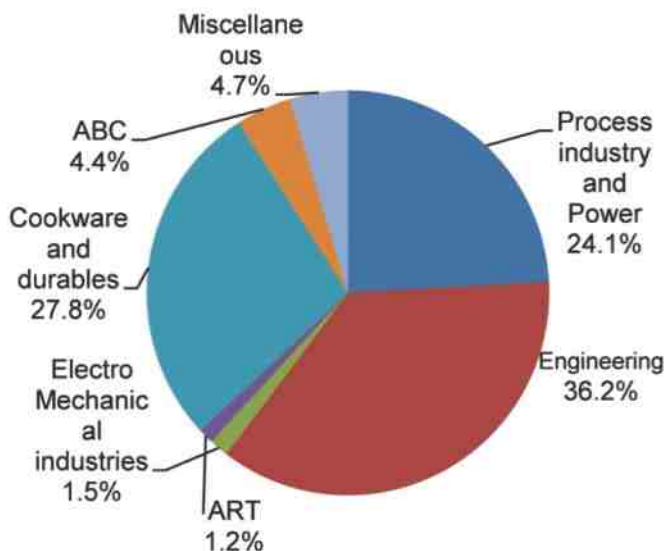

Fig. # 6



Fig. # 7

The automotive, railway and transport (ART) sector is now emerging as the fastest consumption segment of Stainless steel in the country. This segment has grown the fastest 32.39% over the last 8 years propelled by large requirements from railway wagon, coaches and automotive exhausts. The Indian automobile industry has grown rapidly in the past with India emerging as a major hub for small cars. All major international players are having their presence in India. Auto exhausts has been the major consumption segment for Stainless steel in this sector followed by disk brakes, cylinder head gaskets and exhaust manifold gaskets. Almost entire requirement for stainless steel to be used for auto sector in the country is of 409 L grade. Railways too have emerged as the largest consuming segment of Stainless Steel in the ART. Railways are procuring about 2500 coaches and 12000 wagons annually of stainless steel where a mix of 300 series and 400 series stainless steel grades are being used. This procurement cycle is expected to continue for next several years as the railways have plans to switch over to stainless steel for all its coaches for all luxury trains. Besides this there has been rapid growth in demand for

metro coaches in the country and is expected to grow manifolds.

One of the new emerging segments for stainless steel consumption is the architecture, building and construction (ABC) sector. The ABC sector is mostly driven by growth in Indian real estate sector consisting of residential real estate, commercial real estate, retail space, entertainment space, hospitality projects and SEZs. All high quality construction projects like retail outlets, shopping malls, multiplexes, Airports, Rail Metros, IT parks, Commercial Complexes, Hotels, Fast food restaurants, High Quality Residential accommodations, Hi tech townships and showrooms etc in the country today are finding big outlet for stainless steel in different ways and product forms such as Railings, Roofings, Barriers, signages, claddings and building facades. In all these construction, stainless steel is penetrating in place of conventional materials like steel, glass, plastics, aluminium composites etc.

Process industry historically has been consistent consumer of Stainless steel. Stainless steel is used in wide ranging process industries including Refineries, Petrochemical,

Chemicals, Dairy, Power, Textile, Sugar, Food processing, Distilleries, Fertilizer, Cement, Drugs, Paper and pulp and others. This sector mainly consumes 300 series grade of stainless steel. The process and engineering industry requirement has increased over the years and is tied with the health of the general economy and investments in projects. Major share of the consumption within process industry is accounted by Heat exchangers, pressure vessels, reactors and columns etc.

From being a very insignificant player in the world market about a decade ago to become world third largest producer the Indian market has demonstrated a steady growth in the past years. Maintaining this positive trend will require a lot of marketing and development activities. The efforts should be made to ensure that the use of Stainless Steel in infrastructure should be made mandatory by planning commission and specified in the standards. There is a need to create awareness among designers, specification writers about the benefits of stainless steel to reduce the level of ignorance about the material and thus, create new application areas using the life cycle cost benefits of specifying material.

स्टेनलेस स्टील की शताब्दी एवं इसकी भारत में विकास यात्रा

— एन. सी. माथुर (अध्यक्ष ISSDA)

स्टे

नलेस स्टील की खोज वास्तव में मनुष्य की जान लेने वाली बन्दूक की लोहे की नली में नमी व खारेपन से लग जाने वाले जंग से छुटकारा पाने के लिए की गई थी लेकिन शीघ्र ही इसका उपयोग मानव जीवन की रक्षा के लिए मेडिकल में ऑपरेशन के दौरान प्रयुक्त होने वाले सभी उपकरणों में होने लगा। ऑपरेशन उपकरणों में 304 से 316 ग्रेड के स्टेनलेस स्टील का उपयोग होता था। भारत में स्टेनलेस स्टील का आगमन इन्हीं उपकरणों के रूप में हुआ। जिसे जापान ने भारत में भेजा। जापान की निपोन कम्पनी स्टेनलेस स्टील बनाने वाली पहली बड़ी कम्पनी थी। भारत में एल्यूमिनीयम, तांबा, पीतल के बर्तनों का निर्माण अच्छी मात्रा में व शानदार तरीकों में होता था। जापान के एक प्रतिनिधि मण्डल ने भारत का दौरा किया और चैन्नई में दो-तीन इकाईयों को सर्जिकल इक्युपमेन्ट बनाने की ट्रेनिंग दी गई तथा भारत सरकार के साथ एक करार किया गया कि सर्जिकल इक्युपमेन्ट बनाने के लिए जापान 304 ग्रेड की शीट, नाम मात्र प्रोफिट के साथ जीवन रक्षक उपकरणों के निर्माण के लिए देगा और भारत सरकार ने भी आयात ड्यूटी नहीं लगाने का करार किया। लेकिन शर्त यह रखी गई कि जिस व्यक्ति के पास सर्जिकल इक्युपमेन्ट बनाने का लाईसेन्स हो वही आयात कर सकता है। उस समय बहुत सतर्कता बरती जाती थी कि वास्तव में इस शीट का सर्जिकल इक्युपमेंट में उपयोग हो रहा है या नहीं। यहां ज्यादातर ऑपरेशन इक्युपमेन्ट का निर्माण होता था, स्टेनलेस स्टील की सुन्दरता से सर्जिकल इक्युपमेन्ट बनाने वालों के दिमाग में आया कि क्यों नहीं हम इस का प्रयोग कटोरी, थाली, ग्लास आदि बनाने में करें। उस समय यह प्रतिबंधित शीट होती थी इसलिए चोरी छुपके थाली, ग्लास, कटोरी का निर्माण होने लगा। पहले लोगों ने उपयुक्त नहीं समझा लेकिन

धीरे धीरे चलन आरम्भ हो गया। भारत के स्टेनलेस स्टील के बर्तन बनाने वाले देवीलाल कम्पनी ने प्रयास कर सरकार से आयात के लिए सर्जिकल शब्द निकलवा दिया। निर्माता ही सिर्फ आयात कर सकता था देवीलाल ने जापान की निपोन कम्पनी से शीट आयात कर बहुत बर्तनों का निर्माण किया उस समय वह मुम्बई में थी। फिर सर्जिकल इक्युपमेन्ट बनाने वाली इकाई भी ये बर्तन बनाने लगी। चैन्नई में आज सर्जिकल इक्युपमेन्ट के नाम से कई इकाईयां बर्तन बनाती हैं। इस प्रकार भारत में स्टेनलेस स्टील का आगमन हुआ।

स्टेनलेस स्टील का संसार में प्रारंभिक विकास

लगभग 100 साल से भी अधिक समय पहले स्टेनलेस स्टील की खोज हुई और इसका व्यवसायिक उत्पादन शुरू हुआ। इसकी प्रकाष्ठा पर अनेकों वैज्ञानिकों ने शोध किया और इसका परिणाम उन्हे एलॉयड स्टील के रूप में मिला। सन् 1900 के प्रारंभिक दशकों में इसका पेटेंट और निर्माण नहीं था।

सन् 1797 में निकोलस लुइज वॉकेलिन ने क्रोमियम की खोज की। हालांकि सन् 1904 से सन् 1911 के दौर में इसमें कुछ प्रगति हुई और क्रोमियम एलोयड स्टील के साथ बनाया गया। इसी दौर में लियोस एलेक्जेंडर गुइस्ट ने लोहा, क्रोमियम और निकल के मिश्रण से शोध कर स्टेनलेस स्टील का निर्माण किया। इसके बाद सन् 1910-11 में फिलिप मोनार्टज और विलियम बॉर्शर ने स्टेनलेस स्टील के लिए जर्मनी में पेटेंट प्राप्त

किया। मोनार्ज ने एक शोध पत्र प्रकाशित किया जिसमें लोहा, क्रोमियम एलोयज के साथ प्रतिरोधक क्षमता के बारे में विचार प्रकट किये। वह पहले व्यक्ति थे जिन्होंने स्टेनलेस स्टील के कम से कम 12% क्रोमियम और कार्बन की निश्चित मात्रा की आवश्यकता पर व्याख्या की।

स्टेनलेस स्टील के वास्तविक निर्माण का सम्बन्ध कई शोधकर्ताओं से है। सन 1912 में एडवर्ड मोरर और बेल्नो स्ट्रॉस ने काम करते हुए दो क्रोमियम निकल पर पेटेंट प्राप्त किया। जबकि पहली मिश्रित धातु मार्टेन्सिटिक श्रेणी और दूसरी ऑस्टेन्टिक श्रेणी की थी। सन् 1913 में हेरी ब्रेरले ने मार्टेन्सिटिक क्रोमियम स्टेनलेस स्टील की खोज की जब बन्दूक की नली के लिए जंग रोधी धातु की जरूरत थी। अतः उन्होने प्रथम व्यवसायिक स्टेनलेस स्टील तैयार कर ही लिया। सन 1915 में ब्रेरले ने कनाडा, फ्रांस और से U.S. से पेटेंट प्राप्त करने में सफलता हासिल की।

सन 1919-1923 की अवधि में शेफिड कटलर ने स्टेनलेस स्टील के कटलरी, सर्जिकल उपकरण और औजार इत्यादि का नियमित उत्पादन शुरू किया। जल्द ही स्टेनलेस स्टील के टेबलवेयर (बर्तन) जैसे डिश, बॉउल इत्यादि का निर्माण भी शुरू हो गया जो आज भी जारी है। (रेखा चित्र: 1)

100 साल पहले की एक छोटी शुरुआत से स्टेनलेस स्टील मानव जीवन का एक अभिन्न हिस्सा बन गया है। आज के युग में स्टेनलेस स्टील का मानव जीवन में हर क्षेत्र में विभिन्न प्रकार से उपयोग होता है।

अधिक मात्रा में स्टेनलेस स्टील का उपयोग सन् 1950 के दशक से होने लगा जब गर्म और कॉल्ड रोलिंग की सुविधा की शुरुआत हुई। धीरे-धीरे इसके अनेक उपयोगों के लिए अनेक ग्रेड में वर्गीकृत किया गया। वातावरण के अनुरूप इसे ऑस्टेन्टिक, फेरिटिक,

मेरलेस्टिक, डुप्लेक्स और PH जैसी श्रेणियों में वर्गीकृत किया गया। इसकी एक अनूठी विशेषता यह रही कि प्रत्येक श्रेणी में जंग रोधी पाया गया। आज आधुनिक स्टेनलेस स्टील उच्चतम गुणवत्ता वाली श्रेणी का उत्पादन कहलाता है। (मिल उत्पाद बनाने की आसान प्रक्रिया भारत में स्टेनलेस स्टील उद्योग का प्रारम्भिक विकास, रेखा चित्र: 2)

भारत में स्टेनलेस स्टील उद्योग का प्रारम्भिक विकास

यद्यपि स्टेनलेस स्टील पिछली सदी की पहली तिमाही में विकसित हुआ है। हालांकि भारत में इसका उत्पादन कुछ अपवाद के साथ रसोई के कुछ बर्तनों के निर्माण से लगभग चार दशक पहले हुआ था। सन 1978 तक हमारे देश में स्टेनलेस स्टील का उत्पादन केवल नाममात्र का था और जरूरत के मुताबिक इसका आयात भी होता था। सन 1978 में (ASP और VISL) (दोनों स्टील ऑथोरिटी ऑफ इण्डिया के भाग) ने प्रतिवर्ष 18000 मेट्रिक टन उत्पादन घरेलु खपत के अनुसार शुरू किया। उत्पादन 1980 के दशक में और बढ़ा जब नये निर्माता के रूप में बिहार एलॉय स्टील और जिन्दल स्टीपस (JSL) जी.एम. मित्तल (Rathi Alloys) ने अपना कदम रखा और स्टेनलेस स्टील पट्टा निर्माण के साथ रि-रॉलिंग शीट का उपयोग बर्तन इकाईयों के उपयोग हेतु करना प्रारम्भ किया। रि-रॉलिंग पट्टा जगाधरी, जोधपुर, दिल्ली और अहमदाबाद में उपलब्ध होने लगा। तब से घरेलु उत्पादन में 50000 मेट्रिक टन प्रतिवर्ष का आंकड़ा पहुँच गया। स्वदेशी कोल्ड रोलिंग की सुविधा विस्तृत निर्माण प्रतिबंधित कॉयल का उपयोग स्टेनलेस स्टील के रसोई बर्तन बनाने के लिए स्टील ऑथोरिटी ऑफ इंडिया (Salem) ने देश में पहली इकाई 1985 में शुरू की। इसके बाद उत्पादन 102000 मेट्रिक टन प्रतिवर्ष पहुँच गया। इसके बाद पट्टा इकाई को अन्य क्षेत्रों में भी विशेषकर गुजरात व महाराष्ट्र में अनुमति दी जाने से और विकास हुआ।

वर्ष 1990 के दौरान निकल के भाव तेजी से बढ़े और लगभग 18000 US डॉलर प्रति मेट्रिक टन को छूने लगे तब भारत सरकार ने 55% आयात मुद्रा में छूट प्रदान की। तेजी से बढ़े इन भावों के कारण पूर्ण रूप से आयात पर निर्भरता बढ़ गई और स्टेनलेस स्टील व्यापार के देश में फलने फूलने पर संकट के बादल मण्डराने लगे। (भारतीय स्टेनलेस स्टील की ऐतिहासिक टाइम लाईन ग्रोथ, रेखा चित्र:3)

धीरे धीरे आधुनिक प्रणाली से स्टेनलेस स्टील निर्माण तेजी से गुणवत्तायुक्त उत्पादन होने लगा। 60 के दशक के मध्य तक स्टेनलेस स्टील इलेक्ट्रिक आर्क फर्नेस से ज्यादातर निर्मित किया गया। 1990 के दशक में AOD/VOD की प्रद्योगिकी के आगमन ने भारतीय निर्माताओं को मेगनीज और नाइट्रोजन स्टेनलेस स्टील को निकल से बदलने का अवसर दिया। निकल के मूल्य में अस्थिरता ने भारतीय निर्माताओं को शोध करने पर मजबूर किया जिसका परिणाम 200 श्रेणी ग्रेड की एक किस्म का जन्म हुआ। कई नये निर्माता जिनमें मुकुन्द, पंचमहल, फेसर विराज स्टेनलेस स्टील के लम्बे उत्पादों ने उत्पादन में कदम रखा और 25000 MT उत्पादन शुरू हुआ।

स्टेनलेस स्टील उद्योग देश में एक स्थिर गति से बढ़ रहा है। लेकिन 1989-1990 में 90% से अधिक स्टेनलेस स्टील का उपयोग रसोई व इससे संबंधित बर्तनों के निर्माण में हुआ। हालांकि पश्चिमी और अन्य विकसित देशों में स्टेनलेस स्टील का उपयोग अनेक रूप में किया जाने लगा जैसे रेल के डिब्बे, तेल टैंकर, गैस व तेल के लिए पाईपलाइन, पानी टैंकर, विभिन्न प्रकार के मॉडल, भवन निर्माण में उपयोग होने लगा है। (स्टेनलेस स्टील उत्पादन का इतिहास (टनो में), रेखा चित्र:4)

1988 में भारतीय स्टेनलेस स्टील निर्माताओं के प्रतिनिधि ने Ni और Cr के निमन्त्रण पर लन्दन का

दौरा किया। उस समय मात्र चार स्टेनलेस स्टील डवलपमेंट एसोशिएशन सामने आई जो जापान, जर्मनी, इटली और दक्षिण अफ्रीका की थी। इन देशों में आपस में तुलना करने पर स्टेनलेस स्टील व्यापार में खासा अन्तर नजर आया और हमें भारतीय स्टील बाजार के बारे में सोचने पर मजबूर किया। हमने अपने बाजार को बढ़ाने के लिए समानान्तर काम कर रहे विभिन्न संगठनों के साथ तुलना में जब एक बाजार विकसित करने के एक मात्र उद्देश्य के साथ प्रभाव महसूस किया। उत्साह का मार्ग प्रशस्त हुआ और ब्रिटेन से हमारी वापसी के तुरन्त बाद हमने इस पर सघन रूप से कार्य शुरू कर दिया। नवम्बर 1989 में ISSDA नामक नोन प्रॉफिट संगठन का गठन गहन विचार-विमर्श और लम्बी बहस के बाद किया गया। यह वह समय था जब भारत स्टेनलेस स्टील निर्माण का बहुत बड़ा केन्द्र था और निकल की कीमतें आसमान छू रही थी। हमारे मिशन के लिए यह एक कठिन चुनौती थी। हमें भारतीय स्टेनलेस स्टील उद्योग को जीवित रखना था। उस समय Cr-Mn की लगभग 200 श्रेणियों का विकास हुआ।

ISSDA का मुख्य उद्देश्य स्टेनलेस स्टील के उपयोग के प्रति जागरूकता पैदा करना और विभिन्न क्षेत्रों में स्टेनलेस स्टील के उपयोग में मदद करना था। ISSDA और इसकी सदस्य इकाईयों ने जागृति के लिए शैक्षिक गतिविधियों के माध्यम से आमजन को यह बताने का प्रयास किया कि स्टेनलेस स्टील का उपयोग किस तरह से किया जाना चाहिए और इसके क्या क्या फायदे हैं। पिछले दो दशकों में तो अभूतपूर्व बदलाव देखने को मिले हैं। ISSDA अपने मिशन में कामयाब रहा और यह साबित कर दिया कि स्टेनलेस स्टील न सिर्फ रसोई तक सीमित है। स्टेनलेस स्टील एक खूबसूरत इन्जीनियरिंग मेटेरियल है जो आपकी रकम का सही मूल्य देता है।

आज हम केवल रसोई घर तक सीमित नहीं रहे। भारतीय रेल व मेट्रो रेल कोच, वैगन, टैंकर, भवन एवं

निर्माण और परमाणु, पावर, ऑयल व गैस जहाँ उच्च गुणवत्ता वाले स्टेनलेस स्टील का उपयोग बहुतायत होने लगा है। यह सभी हमारे देश में निर्मित हो रहा है और यहीं खपत भी हो रहा है। (रेखा चित्र: 5)

भारत में अन्तिम उपयोग सेक्टर से स्टेनलेस स्टील उत्पादन व उपयोग की प्रवृत्ति

2013 में दुनिया में क्रूड स्टेनलेस स्टील का उत्पादन 3.8 करोड़ टन से अधिक होने का अनुमान है। पिछले 10 सालों में दुनिया भर में 5% तक CAGR में बढ़ोतरी देखी गई थी। एशिया दुनिया का सबसे बड़ा स्टेनलेस स्टील निर्माता व उपयोगकर्ता है। चीन भी विश्व में स्टेनलेस स्टील उत्पादन का 50% से अधिक का उत्पादन कर रहा है। वहीं भारत 2013 में 3 लाख टन तक पहुंच गया। इस प्रकार विश्व में भारत तीसरा सबसे बड़ा निर्माता और दूसरा सबसे बड़ा उपयोगकर्ता बन गया है। भारत में औसत वृद्धि दर के CAGR अनुसार 10% पिछले 10 वर्षों में रहा है।

मूल रूप से खपत को 6-7 व्यापक श्रेणियों में बांटा जा सकता है। जैसे- धातु उत्पाद, प्रक्रिया और इंजीनियरिंग उद्योगों के उत्पाद, इलेक्ट्रो मेकेनिकल - इलेक्ट्रॉनिक, कंस्ट्रक्शन, ट्रांसपोर्टेशन, मेडिकल, सिक्के इत्यादि। इसके अलावा मेटल उत्पाद, प्रक्रिया व इण्डस्ट्रीज के इंजीनियरिंग सामग्री इत्यादि भी मुख्य है। साथ ही परम्परागत रूप से बर्तन और कुकवेयर का देश में स्टेनलेस स्टील का सबसे ज्यादा उपयोग हो रहा है जो कि सम्पूर्ण स्टेनलेस स्टील खपत का 75% में से 52% भाग है। केवल आज बर्तन / कुकवेयर में 4.5% की बढ़ोतरी हुई वहीं तकरीबन 87% स्टेनलेस स्टील की खपत पट्टा उद्योग पूरी करता है। (स्टेनलेस स्टील फ्लेट्स / लॉंग्स की खपत रेखा चित्र:06)

देश में ओटोमोटिव, रेलवे व ट्रांसपोर्ट (ART) क्षेत्र में स्टेनलेस स्टील खपत में तेजी से विस्तार हो रहा है। पिछले 8 सालों में इस क्षेत्र में 32.39% तक की बढ़ोतरी दर्ज की गई है भारतीय ओटोमोबाइल उद्योग में भी स्टेनलेस स्टील की खपत बढ़ रही है। क्यों कि भारत छोटी कारों का विशाल हब बन गया है। ऑटोमोबाइल उद्योग में स्टेनलेस स्टील की खपत ब्रेक डिस्क, सिलेण्डर हेड गार्केट इत्यादि। अधिकांशतः ऑटोमोबाइल्स सेक्टर में 409L ग्रेड का स्टेनलेस स्टील काम में लिया जाता है। रेलवे भी खुद जो अपने आप में बहुत बड़ा स्टेनलेस स्टील का उपयोगकर्ता है औसतन 2500 रेलडिब्बे और 12000 मालगाड़ी के डिब्बों का निर्माण करने में 300 और 400 सिरीज ग्रेड का स्टेनलेस स्टील काम में लिया जाता है। रेलवे नए बनने वाले लक्जरी कोचों के निर्माण में भी स्टेनलेस स्टील का ही पूर्ण रूप से उपयोग कर रहा है। इसी के साथ मेट्रो रेलवे कोचों की मांग भी दिनों दिन बढ़ती जा रही है और अधिक मांग बढ़ने की सम्भावना है। हाल ही में स्टेनलेस स्टील का उपयोग आर्किटेक्चर, भवन, निर्माण में भी होने लगा है। इस क्षेत्र में तेजी से ग्रोथ हो रहा है। जिसमें रहवासीय रीयल एस्टेट, कॉमर्शियल रीयल एस्टेट, रिटेल स्पेस, मनोरंजन स्पेस, हॉस्पिटललिटी प्रोजेक्ट्स और सेज इत्यादि मुख्य है। उच्च श्रेणी के सभी निर्माण जैसे रिटेल आउटलेट्स, शॉपिंग मॉल्स, मल्टीप्लेक्स, एयरपोर्ट, रेल मोटर्स, आईटी पार्क कॉमर्शियल कॉम्प्लेक्स, होटल्स, फास्ट फूड रेस्टोरेन्ट, टाउनशिप, शॉरूम इत्यादि में विभिन्न प्रकार के उपकरण या वस्तुएं स्टेनलेस स्टील की पाई जाती हैं जिनमें रेलिंग, रूफिंग, बेरियर्स, साइनबोर्ड, इत्यादि अन्य कई वस्तुएं फर्निचर वगैरह सभी कुछ स्टेनलेस स्टील का पाया जाता है।

इण्डस्ट्री का प्रोसेस: स्टेनलेस स्टील का उपयोग बड़े पैमाने पर होने लगा है जिनमें औद्योगिक इकाईयां, रिफाइनरियां, पेट्रो केमिकल्स, डेयरी, पावर, टेक्सटाइल्स, सुगर, फूड प्रोसेसिंग, फर्टिलाजर,

सीमेन्ट उद्योग इत्यादि सभी स्टेनलेस स्टील पर निर्भर नजर आते हैं। इन सेक्टरों में लगभग 300 सीरिज ग्रेड का स्टेनलेस स्टील प्रयुक्त होता है। स्टेनलेस स्टील का इस प्रकार उपयोग एक ऐतिहासिक उपयोग कहलाता है तथा सामान्य अर्थव्यवस्था से भी जुड़ा हुआ है।

एक दशक पूर्व दुनिया के तीसरे सबसे बड़े उत्पादक भारतीय स्टेनलेस स्टील बाजार ने वृद्धि दर्ज कराने में

सफलता प्राप्त की। इसी ट्रेण्ड को बरकरार रखने के लिए कई प्रयत्न और नए शोध करने की जरूरत पेश आती है। इसके साथ ही यह भी प्रयास किये जा रहे हैं कि जागरूकता लाने के साथ साथ विभिन्न डिजाइनों और उन उत्पादों के फायदों के बारे में भी साधारण तरीके से जानकारी उपलब्ध कराई जा सके और समय की मांग और आपूर्ति के अनुरूप नई डिजाइनों पर विशेष ध्यान देने तथा इसकी लागत कम रखने की कोशिश की जाती है।



Vertical lift

The Spanish company MP supplied and installed the lifts for the luxury Club "La Stejarii", the most outstanding project of its kind in Bucarest, Romania.

Stejarii Club is a multifunctional sports complex with an impressive and innovative design. This leisure installation has a 21,000 m² constructed surface in 3 different levels. These levels are connected using the MP vertical transport Gearless M^{PGO}!, it has no machine room and it can be completely customized. Another feature is the unique low energy consumption hydraulic lift which is flexible and adapts both for new buildings as well as for refurbishments, it is made completely of crystal glass and stainless steel, with a singular design.

This exceptional lift is placed in the middle of the main room of the complex. Its configuration is completely customized for Stejarii's wishes. Its crystal glass and stainless steel car is intended to be a benchmark design in the lifts sector.

Source: Inoxidable Acero 74



Born on 11th September 1944 at Jodhpur. Graduated with B. Tech (Hons.) from India's leading University - Birla Institute of Technology and Science (BITS), Pilani in 1966. 1st President of students union in 1964 when BITS became an independent University. Worked in India with leading Industrial

Houses for over 48 years (17 years with the Birla Group and for 31 years with Jindals) and has been associated with Stainless Steel Industry for last 38 years.

President of Indian Stainless Steel Development Association (ISSDA), the market development arm of the industry. Chairman of Steel Furnace Association of India.

Associated for 10 years with the "Market Development Committee" as well as "Economics & Statistics Committee" of ISSF (International Stainless Steel Forum), a global Stainless Steel Industry Association based in Brussels, Europe.

Invited to speak in global Stainless Steel, Nickel and Ferro Alloys Conferences worldwide since 1994. Presented papers in over 30 International events organized by Metal Bulletin, CRU, SMR, ISSF,

Stainless Steel Associations in China, Russia, Japan, S. Korea UK, EU, USA, Brazil, Australia, Thailand, Malaysia, Singapore, and South Africa.

Under Mr. Mathur's leadership ISSDA has occupied high reputation with Government of India Ministries and BIS, as the Technical and Market Development arm of the Industry. ISSDA celebrated 25th year Anniversary with a grand event in Delhi in November 2014

Mr. Mathur received The "Stainless Steel UDYOG RATNA AWARD" in Sept. 2009 from the ALL INDIA STAINLESS STEEL INDUSTRIES ASSN. Mumbai during its 42nd AGM. He is the first recipient as an Individual Professional of this prestigious Award for his contribution for the Stainless Steel Industry.

World's Stainless Steel Dignities - What say about N.C. Mathur !

You are one of the very few personalities that make this industry special. Your knowledge and experience in second to nobody, not only from an Indian perspective, but a global perspective since you always connected the Indian stainless industry with the world. You remember that I always introduced you at our conferences as the 'ambassador of the Indian stainless steel industry' - I think a title that describes you best.

Grateful to have you - and your family - as a friend.

Kind regards,
Markus moll, Managing director, SMR, Austria

My Dear Nirmal

Congratulations! I am so very proud of you. You have achieved Celebrity Status in our industry, both for your interesting and sought after talks to the industry, but also because of your legendary market development efforts.

Salute you on this significant anniversary, I salute your absolute dedication to our industry and your genuine love for what you do and for those whose lives you touch.

With my kindest personal regards,

John Rowe, Secretary General, International Stainless Steel Forum

Dear Nirmal

Congratulations; there are not so many people in our industry who can pride themselves of such a track record. The experience and the personal contacts, which you have built up over the years, are a treasure that is valuable to the world stainless steel community.

Best regards,

EURO INOX, Thomas Pauly,
Managing Director, Brussels.

Nirmal,

Congratulations on this important milestone on behalf of the Nickel Institute. We thank you and ISSDA for the great work you have done to advance the use of stainless steel in India.

Best regards,

President, Nickel Institute
Belgium

Congratulations for your 38 years involvement with stainless steel! Also our company has a similar life-time in stainless now and so it is showing for how long we have enjoyed contacts with you.

We would be interested to know more about the report on India + stainless you plan to publish shortly. Kindly put us on the list for information!

With best regards and wishes. Also from Heinz and Gerhard,

We remain
Beatrix Pariser-Nowak, Germany

Dear Mr Mathur

Congratulations! You were one of the first names I noticed in my lists when I arrived here ten years ago and I am very glad you are still on my lists and I have had the opportunity to meet you! I do hope you will stay for at least another 10 years!!

With my very best regards

Jo CLAES (Ms)
Administration and Communications
Manager
International Stainless Steel Forum, Brussels

INDINOX Stainless Steel Conference 2015

25-26 January 2015



**Mahatma Mandir, Gandhinagar (Ahmedabad),
Gujarat, India**



If stainless steel is your business, Gujarat is the place to visit in January

Confirmed speakers and panelists:

Markus Moll, Managing Director, **SMR Steel and Metals Market Research**, Austria

Abhyuday Jindal, Promoter, **Jindal Stainless Ltd.**, India

Yatinder Suri, Country Head, **Outokumpu India Pvt Ltd.**, India

Rakesh Chauhan, Vice President Sales and Marketing, **Viraj Stainless Steels Ltd.**, India

Sunil Nair, Deputy Chief of Research and Development, **Mukand Ltd.**, India

Bharat Mandloi, Managing Director, **Cronimet ABCOM Pte Ltd.**, Singapore

Philippe Richard, Secretary General,

ICDA – International Chromium Development Association, France

Anil Shah, President, **Ni-Met Metals & Minerals Inc.**, Canada

N.C. Mathur, Advisor, **JSL Stainless Ltd.**;

President, **Indian Stainless Steel Development Association**, India

Oswald Wolfe, CEO, **Bahru Stainless**, Malaysia

RK Goyal, Managing Director, **Kalyani Steels Ltd.**, India

Dmitry Kuznetsov Chief Analyst, **Norilsk Nickel**, Russia

Bill Zahner, CEO and President, **A. Zahner Co.**, USA

Hitendra Bhalaria, Managing Director, **Bhalaria Metal Craft Pvt Ltd.**, India

Dinesh K Aggarwal, **Pheonix Appliances P. Ltd.**, India

PV Sanjay, Director Purchasing, Subcontracting & Logistics, **Sulzer India Ltd.**, India

Joachim von Schéele, Head of Application Sales, **Linde India Ltd.**, India

Hans-Joerg Krassnig, Senior Expert Integrated Plant Solutions,

Siemens VAI Metals Technologies GmbH, Austria

Harald Holzgruber, CEO, **INTECO**, Austria



15th international specialized exhibition

HOUSEHOLD EXPO

TABLEWARE • HOUSEWARES • INTERIOR



**ALL
YOU NEED
AT HOME**

TABLEWARE, KITCHEN

HOUSEHOLD GOODS

HOME APPLIANCES

LIGHTING, TEXTILE

Organizers:

LLC «MOKKA Expo Group»,

Group of Companies Mayer J. Group.

Yuzhnoportovaya st., 7, bld. 1, 115093 Moscow, Russia

Tel.: +7 (495) 363-50-32/33

www.hhexpo.ru

**3-5 MARCH
SPRING 2015**

Moscow, IEC Crocus Expo

international home + housewares show

2015

2,100 exhibitors from over
40 countries

60,000 professional attendees
from over 120 countries

gia global
innovation
award
★ ★ ★ ★ ★
honoring housewares
retail + design excellence

Source from leading housewares
manufacturers and suppliers worldwide –
innovative new products not yet available
at European or Asian shows.

Profit from inspiring ideas and qualified
partnerships – first-class learning and
networking opportunities for both
independent specialty retailers and
corporate buyers.

7 - 10 March
Chicago, USA

Show information and free online pre-registration

Visitors: www.housewares.org/attend

Exhibitors: www.housewares.org/exhibit



www.housewares.org/networking



INTERNATIONAL HOUSEWARES ASSOCIATION®
the home authority



International Specialized Trade Fair

HOUSEWARE EXPO



March 16-19, 2015 / September 22-25, 2015

**Russia, Moscow
GOSTINY DVOR Exhibition Complex**



HOUSEWARE EXPO - THE RIGHT WAY TO SELL IN RUSSIA AND THE CIS!

Organized by **GIFTS EXPO**

Under the patronage of the Moscow Government

Under the support of: the Moscow Chamber of Commerce and Industry;
Gifts, Houseware and Costume Jewellery Manufacturers and Suppliers Association.

Tel.: +7 (495) 729-31-38, +7 (495) 972-48-31
expo@houseware-expo.com www.houseware-expo.com

ideal
homeX
HOUSEWARES & GIFT FAIR
by Zuchex

02 05
april
istanbul 2015

Tuyap Exhibition Center - Opening Hours : 09:30 -19:00 Buyukcekmece - Istanbul / TURKEY



Address of **Innovation**

10. International
Housewares
& Gift Fair
Istanbul

Product Groups

- Housewares
- Tableware
- Glassware
- Cutlery
- Decorative Items
- Plastics
- Giftware
- Electrical Appliances
- Bathroom & Kitchen Accessories

LIFE MEDIA
Life Media Fuarçılık A.Ş.

İSTOÇ - Öksüzöğulları Plaza E-1 Blok No:71 Kat:7 Bağlar - İstanbul / Turkey
Tel: +90 212 292 60 31 Fax: +90 212 292 34 20 life@zuchex.com
www.idealhomefuari.com idealhomefair idealhomefair

Tarsus



Türkish Housewares
Züç'ger Association

This fair is being held properly by the law number 5174 of the Union of Chambers and Commodity Exchanges of Turkey.

Presenting the mega opportunity for manufacturers and exporters of Stainless Steel Home Products



Household Products & Accessories | Home Decoratives | Kitchenware | Tableware | Bathroom Accessories | Lawns & Garden



6th Indian Houseware and Decoratives Show

16 – 18 April, 2015

India Expo Centre & Mart,
Greater Noida Expressway, New Delhi



For more information, please contact:

Export Promotion Council for Handicrafts

Tel: 011-26130692, 26135256 Fax: 011-26135518/19

E-mail: homeexpoexhibitors@epch.com

www.epch.in/homeexpo





Asia's biggest houseware event



Hong Kong Houseware Fair

20-23 April 2015

Hong Kong Convention and Exhibition Centre

30th
EDITION

Ufi
Approved
Event

Reserve your FREE admission badge!

Web: www.hktdc.com/ex/hkhousewarefair/03

Wap: hktdc.com/wap/houseware/T119

App: HKTDC MOBILE

Tel: (852) 1830 668 • Fax: (852) 2824 0026

Email: exhibitions@hktdc.org



**Hotel
Sponsorship
for first-time
buyers**

Explore and Connect



Japan's Leading Trade Fairs

60,000* visitors from 55* countries/regions! (*expected)

Held inside **GIFTEX 2015**

6th TABLEWARE EXPO



4th KITCHENWARE EXPO



Dates: July 8 [Wed] – 10 [Fri], 2015

Venue: Tokyo Big Sight, Japan

Organised by: Reed Exhibitions Japan Ltd.

BOOK YOUR SPACE NOW >>>

TABLEWARE EXPO: www.tw-expo.jp/en/
 KITCHENWARE EXPO: www.kw-expo.jp/en/

Organised by



TABLEWARE/KITCHENWARE EXPO Show Management, Reed Exhibitions Japan Ltd.

18F Shinjuku-Nomura Bldg., 1-26-2 Nishishinjuku, Shinjuku-ku, Tokyo 163-0570, Japan
 TEL: +81-3-3349-8519 FAX: +81-3-3349-8530 E-mail: tw-english@reedexpo.co.jp
 A division of Reed Business Registered in England, Number 678640

[INDIA] Reed Exhibitions ISG

Contact: Shammi Srivastava (Mr.)
 TEL: +91-2267716617
 E-mail: shammi.srivastava@reedexpo.co.uk



**TRENDS
fashion
DESIGN**

SÃO PAULO • BRAZIL

EXPO CENTER NORTE

15	16	17	18
Saturday	Sunday	Monday	Tuesday
time: 9 a.m. to 7 p.m.			

**15 to 18
AUGUST
2015**

All year generating businesses.

One of the best options that generates media integration, face to face, between manufacturers, distributors, importers and their main buyers.



CONTACT

Phone: +55 (11) 2105.7000

sales@grafitefeiras.com.br
www.grafitefeiras.com.br

Promotion

Support

Social Activities

Venue

Member



Registration closes at 3pm on August 18th.

This material is subject to alterations with no previous notice. The visitor exempts Grafite Feiras e Promoções from liability for any defects or flaws caused by exhibitors and other service providers.

Press Conference & The Curtain Raiser - Indinox 2015



PRESS CONFERENCE

10 January 2015 at Hotel Fortune Land Mark
 Mr. Ratan Jindal,
 Mr. N.C. Mathur
 Mr. Ugam Raj Hundia,
 Mr. Hiten Bhalaira,
 Mr. Ashok Bhansali,
 Mr. Kushal Bhansali



WORLD STAINLESS STEEL ART FESTIVAL

10 January 2015 at Balaji Hight
 World Stainless Steel Art Festival Catalogue
 Inaugurated by Mr. Ratan Jindal,
 Mrs. Deepika Jindal
 and Sculpture Manufacturers



STAINLESS STEEL SCULPTURE BOOK INAUGURATIONS

10 January 2015 at Balaji Hight

Steel Market Info's Stainless Steel **Sculpture Book**
 Inaugurated by Mr. Ratan Jindal, Mrs. Deepika Jindal
 and Sculpture Manufacturers at Balaji Hight,
 Ahmedabad Duration of "The Curtain Raiser"

STAINLESS STEEL SCULPTURE BOOK

"STEEL MARKET INFO" Made a "SCULPTURE BOOK "A beautiful Collection of Three Hundred Six Stainless Steel Sculpture" We sure that when you will see it you will wish and make a mind to get beautiful sculpture at your office, Factory or Home Garden.

Exclusive Binding Books

Cost 1000/- (By Courier + Rs. 200)

Will be available at **STEEL MARKET INFO's** Stall at **INDINOX 2015** and also **Get it by Order.**

Email: info@steelmktinfo.com • Tel: +91-773 773 1015

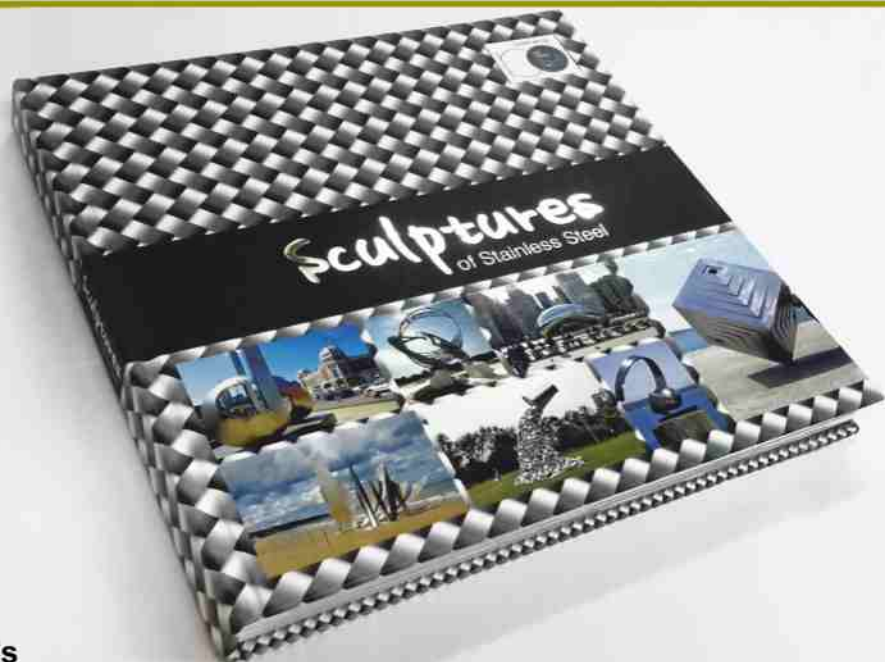

Manufacturers of s. s. utensils,
Cutlery & Gift Articles



Tea Cup



Specialisation

- Double Wall Mug & Cup,
- Double Wall Ice Bucket
- Cutlery Holder & Coaster
- Hotel Ware & Cutlery

Lemon Juicer



Coaster



Cutlery Holder

SHREEPAL OVERSEAS

TO BRING JOY IN PEOPLES LIFE, THUS MAKING IT BETTER

Manufactured & Marketed By:

Shreepal Overseas, Bhayander (E), Thane - 401 105

E-mail : info@shreepal.com www.shreepal.com • Paresh Shah - 9820083664 • Jitu Jain - 9820092547



The Stainless Steel Link was officially launched by a grand ceremony



The Stainless Steel Link was officially launched by a grand ceremony held at The Taj Mahal Hotel on 21st November 2014. It was a ceremony well attended by representative of Stainless steel industry from all over India. In addition to the launch ceremony, the event boasted to wonderful management teachings from the events Key note speaker Dr Radhakrishnan Pillai. The audiences were simply awed to hear the age old wisdom of Guru Chanakya put so simply by Mr Pillai. The audience found the Chanakya Neeti not only soothing to the ears but wonderful in application in day to day life as well.

The audience had unexpected learning's about modern retails from the panel discussion between Mr. Aslam Karmali (Ceo Consumer Division – India & International Retail – Eureka Forbes Ltd), Mr. Neelesh Rangwani (FabFurnish.com), Mr. Robert Roh (Vice President Star CJ – TV Network) , Mr. Sanjeev Mahuli (Business Head Non Food - Reliance Retail), Mr. Sharad Kumar Saraf (Director –Technokraft Industries , India Limited). The excellent moderation by Mr. Bhushan Lawande contributed significantly to the quality of discussion.

The guest of honor, Mr Abhudaya Jindal - Promoter Jindal Steel made an excellent presentation about how India is facing stiff competition from overseas countries and how we should all come together and tackle this challenge head on.

Executive Members from ISDO made a wonderful presentation inviting everyone INDINOX 2015 The event culminated by a wonderful opportunity for everyone to network in addition to the sumptuous food.



ISSDA Celebrates 25 Year Anniversary



Mr N C Mathur, President, ISSDA along with other speakers of Inaugural Session in the Conference

Indian Stainless Steel Development Association, representing leading stainless steel producers and various intermediary industry and users of stainless steel in the country, celebrated 25 successful years of formation in a grand event held in Delhi on 6-7th November 2014. This event was attended by more than 200 delegates comprising leaders from stainless steel industry, chrome, nickel and molybdenum industry.

The event was a crowning moment of the collective hard work, dedication and focused effort of the association and its member companies in diversifying the applications of stainless steel in India and

increasing usage volumes in the country.

Distinguished speakers of the Session One "(L-R) Mr Pramod Kumar, General Manager, Rail Coach Factory, Mr Neeraj R Kochhar, Chairman & Managing Director, Viraj Profiles Ltd, Mr N C Mathur, President, ISSDA, Ar. KalhanMattoo, Founder, Planet 3 Studios Architecture, Mr Yogesh Agarwal, Managing Director, Rimjhim Ispat Ltd and Vijay Sharma, Vice President, Sales & Marketing, Jindal Stainless Limited."

In his welcome address, Mr N C Mathur, President, ISSDA talked about the history of

formation of the Indian Stainless Steel Development Association (ISSDA) which came into being with the objective of diversifying and expanding the domestic market for stainless steel. He reminded the audience of the efforts put by ISSDA and its member companies in transforming the stainless steel production & usage in India which had a production of just about 200,000 tonnes of stainless steel 2 decades ago, primarily for the kitchenware market and has reached to nearly 3 million tones production and 2.4 million tons of consumption in 2013-14 positioning India as the second largest producer and third largest consumer of stainless



Distinguished speakers of the Session One (L-R) Mr Pramod Kumar, General Manager, Rail Coach Factory, Mr Neeraj R Kochhar, Chairman & Managing Director, Viraj Profiles Ltd, Mr N C Mathur, President, ISSDA, Ar. KalhanMattoo, Founder, Planet 3 Studios Architecture, Mr Yogesh Agarwal, Managing Director, Rimjhim Ispat Ltd and Vijay Sharma, Vice President, Sales & Marketing, Jindal Stainless Limited.



steel in the world. Mr Mathur also said "I am glad that we are celebrating our 25th anniversary, when the Indian government is making serious efforts to improve economic condition and support investment initiatives in the various sectors by pursuing policies of 'Make in India' and promoting exports through 'Made in India'." He also stressed on the fact that India's per capita consumption of SS is far below the world average and India's GDP is likely to increase in the near future and major gainers will be Architecture Building & Construction, Automotive Railways & Transport and Process/ Power industries.

The guest of honor for the conference, Mr Syedain Abassi, Joint Secretary, Ministry of Steel & Chairman, JPC also congratulated the Industry for their successes and assured full support of the ministry to strengthen the growth of stainless industry.

During the event, concerns were raised of rising import and dumping of stainless steel in India affecting the domestic stainless steel industries.

Speaking on the occasion Mr. Rattan Jindal, Chairman and Managing Director, Jindal Stainless Limited said, "As imports already control over 40% of the domestic market and quarter by quarter

dumping from countries like China and FTA countries continue to increase. The result of this surge is that today domestic industry which has installed capacity of around 4.5 million tons is operating at just 55% of its capacity and is struggling for its survival". Various other leading producers also raised the same concerns.

The keynote speaker of the conference was Mr Markus Moll, MD, SMR – Steel and Metals Market Research and his presentation "Stainless Steel Strategy 2020 : The Indian Way, the Chinese Way ...or a Third Way" was the highlight of the event.



Mr Rattan Jindal, Chairman & Managing Director, Jindal Stainless Ltd. (Centre) receiving the memento from Mr Syedain Abbasi



Mr. Neeraj R Kochhar, Chairman & Managing Director, Viraj Profiles Ltd. (Centre) receiving the memento from Mr Markus Moll



The keynote speaker of the conference Mr Markus Moll, MD, SMR - Steel & Metals Market Research



Mr Syedain Abbasi, Joint Secretary, Ministry of Steel, was the guest of honour

Several experts from various user sectors representing nuclear industry, petrochemical industry, Desalination & waste water management industry, Construction sector and kitchen & hollowware industry spoke on the potential usage, challenges and offered deep insight on the likely growth areas of stainless steel in their respective sectors.

ISSDA also recognized two Industry leaders, Mr. Rattan Jindal, CMD, Jindal Stainless Ltd and Mr. Neeraj R Kochhar, CMD, Viraj Profiles Ltd., for their outstanding contribution to the stainless steel industry.

ISSDA thanked all its members and participants from around the world for the grand success of this programme.

ISSDA is the technical and market development arm of the Indian Stainless Steel Industry and has close relations with Nickel Institute, stainless steel development associations (SSDAs) in other countries, the International Stainless Steel Forum (ISSF), the International Chromium Development Association (ICDA) and the International Molybdenum Association (IMOA).

Class of Cutlery



Manufacturing of
Stainless Steel
Kitchenware &
Exclusive **Cutlery**
Products

Class of Cutlery



Jayesh Doshi 9322511501
Tushar Doshi 9820218193



K.C METAL INDUSTRIES

13/14 Dewan & Sons Industrial Estate
Village Aliyali, Palghar (West)
Dist. Palghar - 401 404 Maharashtra, INDIA.
Tel : +91-2525-251291
E-mail id : info@kcmetal.in tushar@kcmetal.in
Web site : www.kcmetal.in



PRAJAPATI
STEEL



Shiv Steel Corporation Purab Paschim Furniture

(Since 1985)

Mfrs. of :

Stainless Steel furniture, Sofa Sets, Dinning Sets, Centre Table,
Bed Sets, Sofa Cum Beds, Kitchen Trolleys, Antique Door Grills,
Railings, Hotels' Furniture & All types of architectural fittings.

India's Pioneer Manufacturers of Stainless Steel Furniture

Ramesh Prajapati (Prop.)

Mob. : 9767 777777

1024, Opp. Punjab National Bank, Furniture Bazar, Near Nehru Chowk,
Ulhasnagar - 421 002 (MAHARASHTRA).

Tel. : (0251) 2732083, 2733999

E-mail : prajapatisteelart@yahoo.in

Website : www.prajapatisteelart.com

TORAL[®]
STAINLESS STEEL

Since 1988



First Time in India
PURE STAINLESS STEEL
100% RUST PROOF
KHALBATTA



Patti Tavitha



Zara



Messer



Ravai

S.S. Goti
Pakkad



Brass Goti
Pakkad

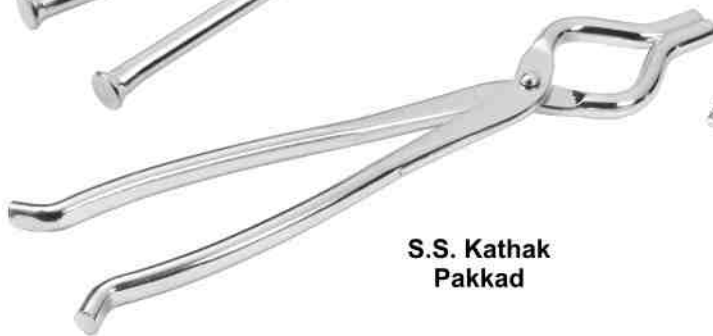

S.S. Kathak
Pakkad

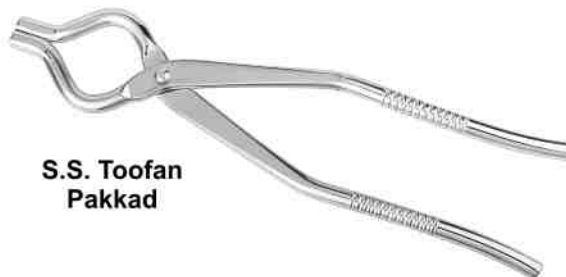

S.S. Toofan
Pakkad

VARA BROTHERS

Manufacturer & Trader of
Stainless Steel Kitchenware
Products in Different Size & Type.

📍 L / 203 / 4, G.I.D.C., Umbergaon - 396 171
Dist: Valsad , Gujarat

☎ (0260) 2993740 / 2563739

✉ toralsteelvara@gmail.com

🌐 www.toralkitchenware.com

TOPAZ INDUSTRIES



**TOPAZ PLAST INDIA
PVT. LTD.**

Classic



Tulip



Designer



Belly Classic



Silver Touch



Royal



Classic



Twins



Jumbo



Wave



Artize



Orchid



(GOVT. RECOGNISED EXPORT HOUSE)

Admn. Office :

Office No-729, 7th Floor, Arun Chamber, Next To AC Market, Tardeo, Mumbai - 400 034
Tel.: - 91 22 66318500 • Fax: +91 22 66310800 • E-mail: info@topazgroup.net • Website : www.topazgroup.net

Feel close to your loved ones
no matter how far you work





INSULOCK

Insu - Jiffin Lunch Pack & Thermal Bag
Also available in Single Lunch Box.



-  **India's 1st Four Locking with Insulation.**
Open it with convenience and without any spillage.
-  **100% Leakproof Lid**
Now carry your favorite food without any leakage.
-  **Easy to Clean**
Comes with removable gasket for easy cleaning.

-  **Temperature Retention**
Special PU insulation helps to keep food hot/cold for hours.
-  **Air Tight**
Keep your food fresh for hours.



Shree Balaji Metal Industries

For Distributor enquiries: (+91-250) 3268699

 / nanonine.in

 / www.nanonine.in

 / NanoNineOnline

 / care@nanonine.in



Spinning Process for Utensils

Spinning sheet metal on the lathe is an excellent means for quickly producing seamless round hollow metal forms. With the help of a lever force is applied uniformly to the rotating sheet metal over the desired form (mandrel) at very high rpms, thus the sheet metal is deformed evenly without any wrinkling or warble.

SPINNING PROCESS

Spinning process is used for making cup or cone shaped articles which are axisymmetrical i.e. rotationally symmetrical hollow shape sheet metal parts. In this process a circular blank of sheet metal is clamped between the mandrel and the tailstock of a lathe-type spinning machine. Mandrel is corresponding to the shape and size of metal part. Both mandrel and blank are rotated by the main drive. The metal disc and the mandrel rotate together and the spinning roller makes contact with the outer face of the work piece. This is explained in Fig.1 below.

In spinning process tension

and compression, both the forces, play their roles since tangential compressive and radial tensile stresses are generated in the deformation zone just as in deep drawing.

This metal spinning technique can be applied to produce a wide variety of hollow parts of widely differing shapes, all without compromising the significant benefits of metal forming. All these features make spinning an economical and highly flexible process.

Some of the items that can be produced by spinning process include: Cones, cups, tumblers, Cylinders and drums, Funnels and horns, Baskets, basins, bowls, Bottoms for tanks, hoppers, and kettles, Canopies, caps, and canisters.

METALS

Almost every metal that is available in sheet form may be spun. However, a few metals are ideally suited to the art of spinning.

Aluminium is fantastically elastic and easy to form so

long as it has been annealed.

Stainless steel is even more elastic (stretching before tearing) than aluminium but requires significantly more force to form. All the austenitic, ferritic and precipitation hardening stainless steels can be formed by spinning process. However the Austenitic range (200-300 series) of stainless steels form best. Type 201 and 301 are the best grades of stainless steel for spinning as these are having the greatest elongation and also the work hardening characteristics. Similarly, the mild steels with lower carbon content are the easier to form.

Copper has excellent elongation (very formable) and doubles its tensile strength when work hardened, but if it hardens before the part is finished then the part must be annealed to prevent shearing and cracking. Brass is a copper-zinc alloy and has similar properties to copper in its formability but brass work hardens less and requires more force.

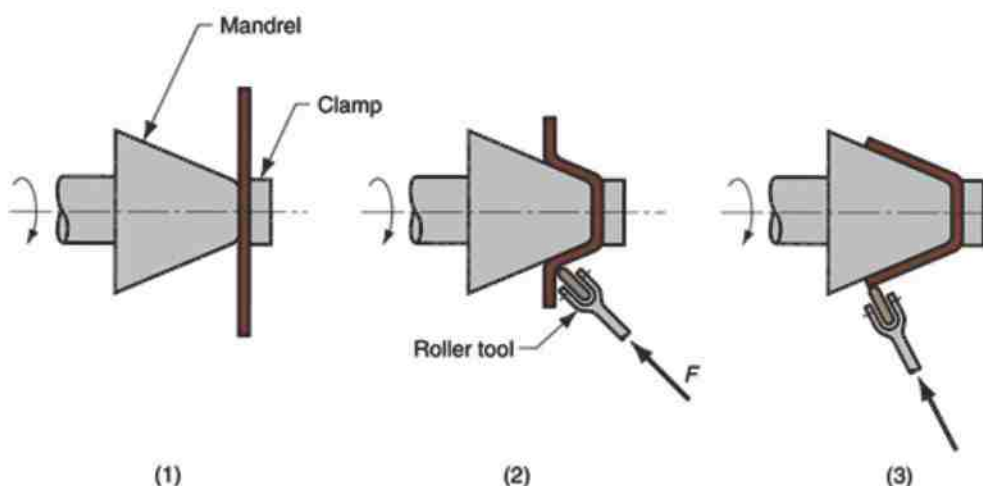

ADVANTAGES OF METAL SPINNING: Metal Spinning offers numerous advantages over other metal forming processes.

MATERIAL YIELDS:

Material yield in spinning process is increased since it uses thinner plate material and the resulting spun product requires little or no machining to finish. Material waste is minimum resulting in significant savings

LOWER TOOLING COST:

Metal spinning mandrels, or chucks, are simpler and less costly. Spinning offers significant savings on the cost and initial tooling investment.

Improved tensile strength:

Due to the pressures and forces being exerted on the material in the spinning process, the component becomes 'work-hardened' i.e. it enhances the material's tensile properties. This in turn it increases the life of the component whilst providing a more light weight, reliable and robust product.

Comparison with deep drawing:

In comparison with deep drawing the spinning process has the following features:

- a) The tooling cost would be reduced for larger components in spinning process.
- b) High accuracy obtained in spinning process.

c) Good surface finish occurred in the products obtained from the spinning process.

d) For small products to be produced in large quantities spinning is not economical

e) The failures of components are low in spinning process and high in deep drawing

f) Machinery and tooling set for spinning process is simple.

g) The mechanical properties of raw material gets increased by 2 to 2.5 times in spinning process than deep drawing.

Article contributed by:
H K Arora
Consultant – Metallurgist
E-mail: h_k_arora@yahoo.com
Phone: 9811131122



INTERNATIONAL TRADING & SOURCING OF SCRAP, SECONDS & PRIME METALS WORLDWIDE.

Akjay International LLC., founded in 2005 is one of the fast growing enterprises in the field of International Trade. Through our vision, hard work and commitment to customer satisfaction we have been successful in establishing ourselves as one of the most trusted name in the field of international trading and sourcing.

OUR STRENGTH

- Solid trading experience
- Superior customer service
- Timely delivery and export services
- Ability to develop new businesses and enter new markets.
- Firm commitments
- Indian associate office

OUR PRODUCT RANGE FOR SALE TO INDIA:

FERROUS SCRAP

- HMS
- Plates and Structural scrap
- Shredded steel scrap
- Busheling
- Cast iron
- HMS Rebar scrap
- Cast iron rotors and drums

NON- FERROUS SCRAP

- Stainless Steel Scrap
- Aluminum Scrap
- Brass scrap
- Copper Scrap
- Zinc Scrap
- Lead Scrap
- Meatballs (Shredded Pickings)
- Zorba
- Electric Motors
- ICW
- Alternators
- Starters
- Cat shells Outer shells SS 409

STEEL AND STAINLESS STEEL PRODUCTS (Prime and Secondary)

- Coils
- Sheets
- Plates
- Pipes
- Wire Rods
- Strips

Looking for Opportunities to Import Various Prime Ferrous and Non-Ferrous finished Products into the US.



3175 Route 10 East, San-Mar Square, Suite # 400, Denville NJ - 07834 - 3521, USA

Phone: 001 - 215 - 441- 8751 (Ext-2) Fax : 001 - 215 - 441- 8751, E-mail : akjay@akjayint.com, Website : www.akjayint.com

OUR QUALITY IS OUR GUARANTEE



Aristo Steel Pvt. Ltd.

Panjrappole Road, Mumbai - 400 004 (INDIA) • Tel.: +91 22 - 2242 6555 / 2242 2666 / 2242 2435 • Fax: +91 22 - 2242 7324 • E-mail: aristo_steel@yahoo.co.in

KITCHEN ESSENTIALS™

COMMITTED TO EXCELLENCE
AN ISO 9001: 2008 ORGANIZATION

STAINLESS STEEL COOKWARE



Modak Maker

Mini Multi Kadai 3 in 1



HARD ANODISED COOKWARE



4 Pcs. HA Trendy Cooking Set

2 Pcs. Induction Friendly Starter Set



6Pcs. HA Cookware Set

PRESSURE COOKER



5 Ltr. HA Kalash Cooker (Induction Base)

6Pcs. Black Beauty Gift Set



5 Ltr. Kalash Cooker (Induction Base)



3 Ltr. HA Kalash Cooker (Induction Base)

WORKS ON GAS + INDUCTION
+ ELECTRIC + CERAMIC + HALOGEN

STAINLESS STEEL • HARD ANODISED • ALUMINUM

KEYUR KITCHENWARE

KUNAL INDUSTRIAL ESTATE, UNIT NO. 5,
GAURAI PADA, NEAR SBI, VASAI EAST, DIST. THANE • PIN 401208, INDIA.
Tel.: +91-250-6054885 / 6054886 / 6454886
Email: info@kessentials.com, domestic@kessentials.com

www.kessentials.com
www.kessentials.in

f he magic of a clear night sky filled with stars has inspired many creative souls. Now, through a collaboration between science and art, a stainless steel sculpture installed at the Australian National University in Canberra brings new depth to the connection between ourselves and the stars above.

The 4 metre diameter, mirror-polished stainless steel sphere (called UNA), which sits in the science precinct at ANU, is so much more than first meets the eye. Designed by UK artist Wolfgang Buttress, UNA features 9,100 laser-cut perforations, which were mapped in collaboration with ANU astrophysicist Dr Daniel Bayliss.

The holes match the 9,100 stars that we can see with the naked eye from Earth and vary in size according to the brightness of the stars in the night sky (the brighter the star, the larger the hole).

Inside the sphere sits a second, two metre diameter mirror polished, stainless steel sphere. When viewed through one of the outer perforations, the internal sphere reflects small points of light from the outer sphere, creating, according to Mr Buttress, a microcosm of our perceived night sky.

“One makes connections to one self and the stars above. We are all made from stardust,” he said.

Star Light, Star Bright

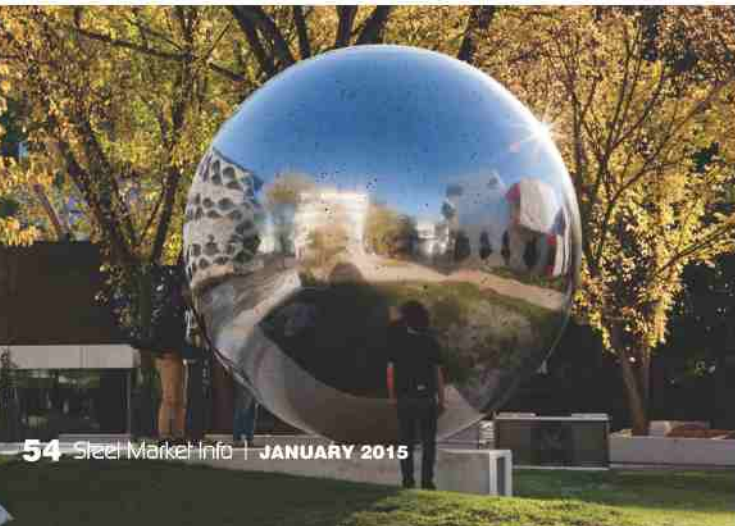

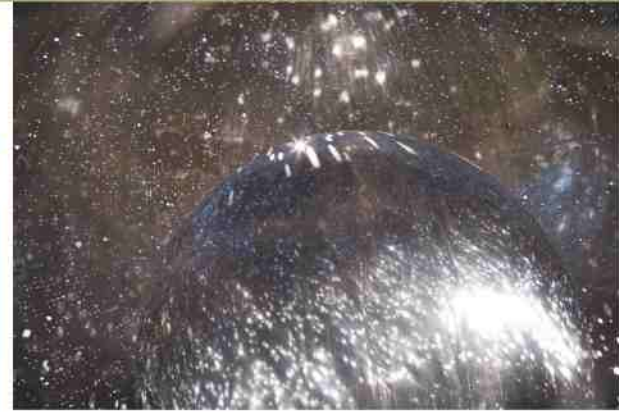

The magic enters a different realm at night, thanks to the fibre optic lights that sit in the centre of the two spheres, casting a glow through the perforations.

Mr Buttress said the use of stainless steel and high quality fabrication were integral to the success of the project.

Aside from the ability to be mirror polished, he said stainless steel was specified due to its strength, resilience and, if maintained properly, the fact that it will look as good in 50 years as it does now.

The spheres incorporate around 2000kg of 4mm 316L, 2B finish stainless steel, which was supplied in 24 pieces by ASSDA Major Sponsor Sandvik Materials Technology (now Vulcan Stainless). The pieces were laser cut to shape in-house on one of Sandvik's four laser machines. Sandvik VIC/TAS State Manager Stephen Orridge said each hole was unique in its shape and the work involved about 40 hours of programming.

The sheet was pressed by Dished & Flanged Ends to create the curved forms for both the inner and outer spheres. ASSDA Member and Accredited Fabricator NRG Piping then

joined and welded each segment with only 1mm tolerance, followed by polishing. NRG Piping co-ordinated the fabrication, transport and installation of UNA.

Mr Buttress said the welding had to be done carefully to minimise distortion as all would be seen when it was mirror polished.

"There is nowhere to hide. NRG Piping are amazing fabricators as they totally understand the properties and essence of stainless steel," he said.

Because the inner sphere had to be positioned inside the outer sphere during the fabrication process, a 600mm hole at the base allowed enough room for a welder to get access inside to polish out the internal welds.

The end result is one of the artist's favourite pieces that he has created. "By day, the inner world is revealed on close inspection and at night it has a different character as light pours out of her like a beacon. It works on a micro and macro level, at day and by night. It was a great marriage between art, architecture and engineering," Mr Buttress said.

Images courtesy of Ben Wrigley.

This article is featured in Australian Stainless magazine issue 54, Spring 2014.

Cold Forming Is Shaping The Future for Stainless

as a method of manufacturing precision components, cold forming has dipped under the radar of many engineers. However, the development of cold forming stainless steel looks set to revolutionise the way this material is manufactured, says Mark Jennings, Technical Director at Dawson Shanahan.

Cold forming has long been established as a method for producing simple, high volume components such as fasteners quickly and cost effectively. Increasingly though, this process is being used to produce high precision components from a range of advanced engineered metals. More significantly, a new technique has now been developed by Dawson Shanahan enabling the production of cold formed austenitic and martensitic stainless steels that virtually eliminates galling. This manufacturing breakthrough has offered new opportunities and benefits for component manufacturers operating in a diverse range of sectors, from aerospace and automotive engineering through to medical, electronic and optical instruments. Unlike the traditional energy intensive, time consuming, wasteful or even hazardous methods of shaping metal, cold forming, is a particularly simple process that produces metal components at low ambient temperatures without removing any material.

Precision pressure

A typical cold forming press uses coiled wire at room temperature that is then cut to length then using advanced mould and die sets,



combined with extremely high levels of applied pressure (in excess of 600 tonnes), and extruded to the desired shape. By working with the material and eliminating the need for trimming and cutting, cold forming can cut waste by up to 80% in comparison with traditional machining processes.

Faster output, lower energy consumption

As cold forming is carried out at ambient temperatures, this high speed process can be completed 15 times faster than more conventional options, significantly saving on production time. As a result, components can be made precisely to order extremely quickly, cutting lead times and the need to

store high volumes of spare parts on site. Another, perhaps more obvious, advantage of producing components at ambient temperatures is the significant reduction in energy consumption, helping to reduce costs still further, as well as carbon footprint. Indeed, these benefits can help lower the costs of components by as much as 70% in many instances.

Stronger, smoother parts

Just as importantly, the cold forming process can improve the mechanical properties, with a finished part 18% stronger than that of machined components. Unlike machining where sections are usually cut across the grain structure of the metal, the direction of forming and the geometry of the part is aligned with that of the grain. In addition, finished parts can have complex internal and external geometries, with exceptionally smooth surface finish, so that only minimal secondary processing is needed.

This offers the potential for design engineers to specify components to a higher specification and provide that competitive edge in performance.

Stainless steel components

While the technique has long been used with other advanced engineering metals such as copper, aluminium and brass, the inherent strength of stainless steel has been something of a stumbling block for the cold forming process. For engineers today, there is now an alternative to more conventional processes using a safe cold forming technique developed by Dawson Shanahan. This latest innovative development now means that stainless steel, as well as other exotic metals such as titanium, can be cold formed using a specialised metallic

lubrication and extrusion coating avoiding the need for hazardous chemical solutions. This unique shell, created by the research and development team at Dawson Shanahan, eliminates the problem of galling, to prevent damage being caused to the components and tooling, which often presents itself in the form of scores or surface imperfections, thus maintaining consistent quality in finished parts. In fact, this new technique has been endorsed by independent laboratory test results, which show that this ground-breaking process retains all the mechanical properties of stainless steel without any detrimental effect on performance.

The advantages of this new process will be of particular benefit to those areas of industry requiring robust, ultra-high precision parts, including laser applications, where cold formed nozzles significantly increase cutting accuracy, or in industrial engines where the parts are used to boost overall reliability, while cutting CO₂ and particulate emissions. Equally, other stainless steel components made through cold forming, such as diesel injectors for example, are generally more reliable especially when used with biofuels, as these fuels can place greater stresses on conventionally manufactured parts.

With growing demands from industry, combined with the need to reduce wastage rates and energy consumption for both economic and environmental reasons, an increasing number of manufacturers are looking to adopt more efficient and cost effective methods of producing stainless steel components. This new development in cold forming looks set to revolutionise the way stainless steel components are manufactured in the future, by using a more sustainable and responsible approach.

Source: SSI, Vol 41, December 2013

The Art Of Recycling A Completely Recyclable Material

among the main characteristics of stainless steels, we can include their complete recyclability. Stainless steels do not produce any environmental pollution at the end their lifecycle, and are destined to become scrap metal. A company based in the province of Brescia, developed the idea to recycle the waste and the surplus resulting from stainless steel production processes, and opened a special division called "Inoxcart". In this division, the processing waste of EN 1.4301 (AISI 304) stainless steel is reused to create minimalistic objects characterized by a clean,

smooth and essential design inspiring to the simplest geometrical shapes. These objects are ennobled by the typical characteristics of the material then oriLmate from: solidity and robustness, along with resistance to corrosion, and particularly, corrosion produced by atmospheric agents. These objects enclose functionality, strength, and cost effectiveness within the stainless steel recycling chain, and therefore, respect for the environment that surrounds them.

Thanks to Davighi International (www.davighi-international.it)

Source: inoxsidabile 196





M.A. ENTERPRISES

Manufacturer of Stainless Steel Sheets



Stainless Steel Sheet

Thickness **1** mm to **7** mm



Fact. & Administrative Office

508, G.I.D.C. Industrial Estate,
Mehmdabad Highway Road,
Phase IV, VATVA,
Ahmedabad - 382 445, Gujarat.



Tel.: +91-79-25831384 / 85



maenterprisesadi@gmail.com
enquiry@ma-enterprises.com



Ashok Bhansali : +91-9825030604

Dilip Bagrecha : +91-9327002895



www.ma-enterprises.com



Mumbai Office: M.A. Metals

Prakash Bhansali : +91-9322233687



STAINLESS STEEL

PURAN MAKER BOWLS With Stainless Steel 5 Jalis



www.komalsteel.com

Mfgd. & Marketed by

KOMAL TRADING CORPORATION

B/12 Vaishali Industrial Estate, B.T. Road, Dahisar (W), Mumbai-400 068.

Tel: +91-22-22223333, Fax: 28926188, Mob: + 919820087177

E-mail: komal@vsnl.com / komal@mtnl.net.in /

tekchandbheda@gmail.com Website: www.komalsteel.com



STAINLESS STEEL

OIL DISPENSER

www.komalsteel.com



Easy to Open



Easy to Fill



Easy to Pour



Easy to Clean



Mfgd. & Marketed by

KOMAL TRADING CORPORATION

B/12 Vaishali Industrial Estate, B.T. Road, Dahisar (W), Mumbai-400 068.

Tel: +91-22-22223333, Fax: 28926188, Mob: + 919820087177

E-mail: komal@vsnl.com / komal@mtnl.net.in /

tekchandbheda@gmail.com Website: www.komalsteel.com

Available Size

350 | 500 | 750 | 1000 ml.

MADE IN INDIA

An ever-changing masterpiece

If a building becomes architecture, then it is art. (Arne Jacobson)



London's architect Zaha Hadid, famous for her stunning designs, had a clear vision for the Eli and Edythe Broad Art Museum on the East Lansing campus of Michigan State University. She wanted "...a structure that changes as visitors move past and through it – creating great curiosity...". Her desire to echo the surroundings

with a skin made of a series of pleats needed a material that could express her vision. Stainless steel's reflectivity and its ability to be molded and bent to any shape proved to be the perfect solution.

Defining the questions

Designing and constructing a world-class art museum poses many challenges, and requires collaboration and cooperation of many parties, each with different priorities. One of the issues was façade material selection. There were several questions the team had to consider with respect to stainless steel as a candidate.

Would it be the right material? Could a stainless steel exterior be built within the available budget? What grade of stainless steel should be used? To help answer these questions the design build team invited Zahner, an architectural fabricator, well versed in the manufacture of stainless steel façades, and other outside consultants to support the project.

Developing the answers

Alloy and surface finish selection –

For a stainless steel façade it was important to select the correct grade to ensure low maintenance and a long life. Because the museum would be exposed to East Lansing's road and walkway de-icing salts, the design team chose the molybdenum-containing Type 316L (UNS S31603) grade. With an Angel Hair® finish, this grade also had the desired appearance: a relative gloss several levels lower than other grades, producing a softer, more consistent and more

attractive finish.

Feasibility demonstration – The outside consultants argued that stainless steel would be too expensive, could not be welded, and could not develop the design's sharp pleats. They suggested instead a composite structure for the façade. However, the fabricator, who has helped to construct some of the most striking stainless steel buildings in the United States, produced several large-scale stainless-steel mockups of the pleats and welds. These educational and strikingly beautiful mockups demonstrated that stainless steel would fulfill the architect's vision and even exceed everyone's expectations.

Other teams produced alternative façade mockups of aluminum composite panels with a silver paint coating and non-welded joints. There simply was no comparison between these and the stainless steel

design. The design team recognized that the Type 316L stainless steel, fabricated as proposed by Zahner, would have much greater impact. The stainless steel could be welded and assembled to create

sharp angular planes as if the entire building were machined from a block of gleaming metal, making it a beautiful, iconic sculpture on the campus. One additional significant benefit of the choice of 316L was that at the building's end of useful life, the stainless steel could be fully recycled. In contrast, a composite façade could not be completely recycled.

Panel fabrication – The 316L stainless steel pleats were made from 1.5 mm thick sheets that were custom V-cut to create the pleats. The fabricator used a specially designed mill with an accuracy of 0.005 mm to make these cuts. The formed stainless steel sheets were strong enough that they required no backup support. Each pleat was made of several formed panels, using in total 970 unique panels. The end panels of each pleat were fusion welded using Type 316L wire, argon shielding gas and copper heat sinks to eliminate distortion. These measures kept the weld cleanup and passivation to a minimum.

A breathtaking result

Michigan State University is very pleased. The Eli and Edythe Broad Art Museum is an incredible, iconic building. Thanks to the choice of 316L stainless steel, keeping it stunningly beautiful requires only a fresh water rinse in the spring and autumn. For years to come, passersby will be drawn towards this piece of art. (WZ) Angel

Hair ® Trademark of A. Zahner Company

Source: IMO A

Jindal Stainless launches first of its kind Stainless Steel Modular Toilets

Stainless Steel modular toilets to provide thrust to Swachh Bharat Abhiyaan
Convenient and durable, can last for 25 years or more with minimal maintenance

Mew Delhi, 9th December 2014: Providing an impetus to Government's Swachh Bharat Abhiyaan, Jindal Architecture Ltd., a subsidiary of Jindal Stainless Ltd. has announced the introduction of economical, eco-friendly, durable and convenient stainless steel modular toilets, as part of its expanding product range. The 100% recyclable toilets are available in a range of single units and as community toilets of six and eight units, respectively. These toilets have the option of being upgraded to automated bio-toilets.

Emphasizing on the need of modular stainless steel toilets in India, Mr Anuj Jain, CEO, Jindal Architecture Limited said, "Human waste disposal is an ever-growing, perennial problem

arousing aesthetic inhibitions, together with the threat of infectious diseases due to the contamination of groundwater. Less than 30% of Indians presently have access to toilets. In rural regions, only 10% of houses have toilets, with the rest resorting to open defecation. Although people in cities have better infrastructure facilities, nevertheless, here also just 70% have access to toilets. This increases mortality rates because untreated waste causes diarrhoea, amoebiasis, cholera, typhoid and other dangerous diseases that threaten the lives of lakhs of children and their families."

Open defecation is one of the main causes of diarrhoea, causing the annual deaths of

more than 750,000 children less than five years of age. [1] Significantly, many of these deaths occur in India, where almost 30 million schoolchildren lack access to toilets. As many as 595 million Indians practice open defecation daily – almost 45% of the populace.

Stainless steel modular toilets provide an appropriate solution for this longstanding problem. In terms of structural strength, product life, maintenance, hygiene, eco-friendliness and scrap value, stainless steel toilets have proved to be better than fibre, mild steel or brick-and-mortar toilets. Due to the modular design, the toilets can be assembled on site, saving time and transportation costs.





Weather resistant and with PVD-coated interiors, they can be installed easily at government schools, hospitals, tourist places, pilgrim centres, marketplaces, public auditoriums and fairs, railway stations and bus stands.

Most importantly, these are competitively priced against fibre or brick-and-mortar toilets – a single-unit toilet costs Rs.99,999 onwards, while the community toilets which are six units start from Rs. 3.99 lakhs and eight unit starting from Rs. 4.99. The disposal tanks cost approximately Rs59,000 per unit. Moreover, a bio-digester tank solution is being jointly developed with the DRDE, Railways and RDSO, which will solve hygiene issues on railway tracks and areas around them by converting human waste into gases and water with the help of specially-developed anaerobic bacteria that survive on such waste.

As part of this initiative of the government and as a responsible corporate, Mr Anuj Jain said, “As corporate citizens, we should seriously consider our responsibilities and focus our CSR initiatives in eliminating the practice of open defecation. This can be achieved by creating awareness to trigger behavioural changes that end such unhealthy practices. Towards this goal, Jindal Stainless has

developed India's first stainless steel modular toilets with bio-disposable tanks, focussing on areas where accessibility to toilets and waste disposal is abysmal.”

About Jindal Stainless Limited

Jindal Stainless, a part of the \$18 billion USD, OP Jindal group is the largest integrated manufacturer of stainless steel in India and is ranked among the top 10 stainless steel manufacturers in the world, with a capacity of 1.8 million tons. JSL has crafted its success story by fully integrating its operations based on a strategy of both,

backward and forward integration, starting from mining, melting, casting, hot rolling to cold rolling and further value additions. An ISO: 14001 compliant, JSL product range includes: Ferro Alloys, Stainless Steel Slabs, Blooms, Hot Rolled Coils, Plates and Cold Rolled Coils/ Sheets, Stainless Steel Strips for Razor Blade

Steel and Coin Blanks for mints in India & EU.
www.jindalstainless.com

For more products details please contact:

Pushpa Chowdhary

Email Id:
pushpa.chowdhary@jindalsteel.com

Phone: +9971793877

[1] UN Access to Sanitation report, updated 23 October 2014



Mfrs & Exporter
of Exclusive
Bath & Bar
Accessories



Bar
Accessories



Bath
Accessories



Bathroom
Accessories



Kitchen
Accessories



Barware
Accessories

www.saminternational.co.in
www.sghome.in

SAM INTERNATIONAL
A-24, Pul Pehladpur, Suraj Kund Road,
New Delhi - 110044
Tel.: 011-26361220, 26366030, 65569312
Fax No.: 011-66173941
Toll free no.: 1-800-11-6030
Email: info@saminternational.co.in

CASSEROLES



GIFT SETS



LUNCH PACKS



SOFTLINE SERIES



AN ISO 9001:2008 CERTIFIED CO.

THERMOWARE & HOUSEWARE

S.S. CASSEROLES

ANMOL SERIES



FLASKS



SNACK PACKS



WATER BOTTLES



WATER JUGS



NON-STICK 3 MM



Touching Lives...
Winning Hearts!

Contact us:

PALMLINE PLASTICS PVT. LTD.

A/16, Tirupati Udhog Nagar, Sativali Road,
Vasai (E) Dist. Thane 401 208.

Email : palmline@rediffmail.com

palmline96@gmail.com

Website : www.palmlineplast.com

www.indiamart.com/palmlineplastics/

**FOR DISTRIBUTOR ENQUIRY
KINDLY CONTACT ON:**

LALIT K. JAIN - 9821279244

NIRAJ K. JAIN - 9867023723

A Pioneer and Leader In Metal Finishing Machines



G Grind Master is happy to be a Gold Sponsor at INDINOX 2015 which is a Mega Event at Ahmedabad.

Grind Master, a pioneer and leader in metal finishing machines, boasts of "The Widest Range" of belt grinding & polishing machines for Cookware, Stainless Steel Tubes & Bars. Started in 1984 Grind Master has state of the art design and manufacturing facility spread over 100,000 sq. Ft., a motivated team of 200 and more than 4000 machines across 6 continents.

India has a large number of stainless steel sheets, tubes, bars & cookware manufacturers. Grinding and Polishing are extremely important processes which add the value to all these products. Grind Master is offering world class machines for polishing stainless steel to various finishes. Our Indian stainless steel Industry can immensely benefit from Grind Master's in depth

knowledge of various polishing processes and consumables so as to achieve desired polishing results in shortest possible time and optimum cost.

INDINOX has given the right platform to show case these technologies. The visitors of INDINOX can witness the demo of following machines at INDINOX.

1. Cookware Polishing Machines-From simple semi-automatic double ended machines to fully automatic rotary indexing type polishing machine. Further, we have implemented robotic loading / unloading of the pot on our rotary indexing machine which polishes 200 pots per hour without any operator.

2. Tube Polishing Machines - Grind Master offers widest range of centreless machines for polishing round tubes and bars, from low cost LMCL and GCL models to

**Rotary Indexing
Type Polishing
machine**



**Semi
Automatic
Buffing**

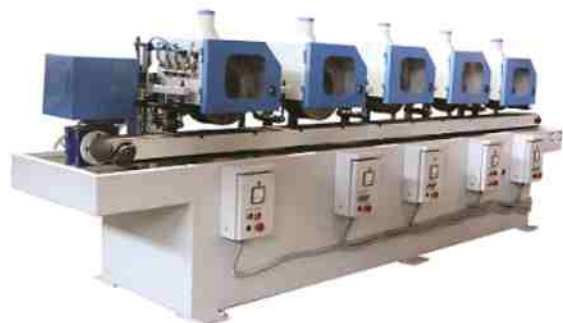

**Plate
Polishing**



**Tiffin
Box
Polishing**

**Square
Tube
Polishing**



**Round
Tube
Polishing**



highly sophisticated FH series models with fully automatic job size setting and loading / unloading. Our centreless machines are very easy to set for different tube sizes and very user friendly. The running cost on our machine is found to be lower than competing machines. We have shown better finishing results with lesser no. of polishing heads, thereby achieving a big saving in electric power cost

3. Descaling / Grinding and Polishing of wire rods and Bright bars- Grind Master offers multi head Centreless Belt Grinding and Polishing Machines for round bars. From the raw black bar, you can get ground and finished bright bar on this machine. The process of belt grinding removes the surface defects at much higher speeds as compared to the conventional wheel grinding. VSM Ceramic belts for roughing and compact grain belts for finishing give

highly consistent finishing results. With this machine, you can cost effectively achieve finishes up to 0.12 Ra and h9 tolerance

Stainless Steel Sheet finishing – Grindmaster in collaboration with Timesavers, Holland offers a range of sheet grinding and finishing machines for achieving No. 4 finish. We offer dry as well as wet finishing machines for stainless steel sheets and also offer coil to coil grinding and finishing lines.

Grind Master has proven track record of introducing automation in several grinding and polishing applications. A Grind Master solution is characterized by design led innovation supported by a robust organization and strong service.

A result of absolute Engineering with passion !



Grinding and Polishing Machines for bars



sheet grinding and finishing machines

Grind Master Buzz

Grind Master bags "SME of the Year"

Grind Master is the Proud Recipient of the "SME of the Year" Award in the Emerging India Awards 2014, presented by ICICI and CNBC. The awards were presented at a ceremony in Mumbai on Saturday 13/ 12/ 2014. Grind Master Also received the Award for "Engineering and Capital Goods Vertical, and Nomination for "Women Entrepreneur of the Year".

Grind Master is one of the few machine tool builders from India competing on a Global level with Japanese and German companies, supplying Mission Critical Microfinishing Machines to Global Automotive OEMs such as Shanghai General Motors, SAIL, Renault Nissan, Kirloskar Toyota, SGMW and Great Wall. With "Widest Range of Metal Finishing Machinery in the World", Grind Master has developed home grown technology and know how. Mr. Milind Kelkar, after receiving the award said "We are proud to build International Standard Products with blood, sweat and tears. This award is dedicated to what I believe is the finest machine building team in the country".

2014 has been an excellent year for Expanding our Business and Technologies. With Successes such as the Setup of Grind Master China Office, and Technical Collaboration with SAMP Italy, "SME of the Year" Award is like an icing on the cake. With Imtex 2015 around the corner and many new Product Launches, there is a lot to look forward to in 2015.



Public Sanitation Facilities in Stainless Steel The Need of the Hour



a comprehensive, affordable, sustainable and hygienic solution aimed to cater to the basic and diverse sanitation needs of the common man is the need of the hour. A country of the size of India with huge population and rapidly expanding cities has been lacking in the public sanitation facilities at all fronts. Though the efforts have been made in past to build and improve upon yet the problems on account of difficulty in maintenance, periodic breakdowns and maintaining a standard of hygiene, when using conventional kind of sanitation facilities, has remained a challenge for successive governments.

Under this context, Eram Scientific Solutions (ESS), a home grown social enterprise based in Kerala, has introduced toilets which effectively addresses the challenges faced at sanitation front. Having identified the dimension of issues prevalent in sanitation, ESS has ensured the soundness and reliability of the innovation by integrating new technologies and better materials at affordable cost for catalyzing better hygiene and sanitation practices.

eToilets are built of Stainless Steel enclosures and have electronic systems for enhancing user experience and for tracking the health status of these toilets. eToilets have automated access control systems, sensor enabled water minimization, self-washing and floor wash mechanisms.

The custom-sized Stainless Steel enclosures are extremely durable, corrosion-resistant and are unswerving in the long run.

the squatting pan. The P-trap also helps to prevent foul smell inside the toilets and thus ensures cleanliness round the clock. Unlike the ceramic or plastic closets, the SS closet structure is strong enough to withstand heavy weight and major damages. One eToilet SS Model weighs approximately 310 Kgs. the squatting pan. The P-trap also helps to prevent foul smell inside the toilets and thus ensures cleanliness round the clock. Unlike the ceramic or plastic closets, the SS closet structure is strong enough to withstand heavy weight and major damages. One eToilet SS Model weighs approximately 310 Kgs.

Benefits of Stainless Steel Structure

1. Robust structure
2. Ease of assembly at field
3. Aesthetics and high ambience
4. Highly modular
5. Withstand extreme weather in Indian context
6. Ensures serviceability and ease of cleaning
7. Environment-friendly
8. Sustainable in coastal areas

Besides offering a menu of most modern technology options the eToilet has a facility of pre-flushing before entering, automatic flushing once usage is done, in-built water tanks, sensors for water and electricity conservation, automatic platform, cleaning and power back-up with coin operated entry. Keeping in mind individual needs these toilets are programmed to flush 1.5 litres of water after three minutes of usage or 4.5 litres if usage is longer. The performance status of the units can also be monitored via web using GPRS connectivity of the units. This innovation involves unmanned operations and thus ensures easy and continual operation of the toilets while minimizing unnecessary maintenance costs.

via web using GPRS connectivity of the units. This innovation involves unmanned operations and thus ensures easy and continual operation of the toilets while minimizing unnecessary maintenance costs.

School Model eToilets :

Considering the sanitation grounds in India, it is quite obvious that the existing sanitation amenities prevailing in schools have largely failed to deliver and promote a sustainable sanitation model especially in capacities of sustenance, health and hygiene for the students.

Rethinking traditional CSR guidelines, ONGC has set an example through the implementation of it in a local school in Malappuram District in Kerala. ONGC has set up 3 eToilets in Government Higher Secondary School Karuvarakundu, the only government run school

in this village in Malappuram. Home to 4096 students and 110 staffs, the school has come under the limelight with this social intervention undertaken by ONGC.

Now since the newly elected government in India has taken a pledge to build and improve on public sanitation facilities as a tribute to Great Mahatma Gandhi whose 150th birth anniversary will be celebrated in 2019 under Mahatma Gandhi Clean India Programme. It is most likely that efforts will be made to install more and more of extremely durable and maintenance free sanitation facilities around the country.

For more details contact :

Mrs. Bincy Baby
 Head- Convergence Business Group
 Eram Scientific Solutions
 KEK Towers, 5th Floor Opposite. TRIDA,
 Vazhuthacaud,
 Thiruvananthapuram- 695 010, Kerala
 Phone : 0471-4062125
 Email id : bincy@eramscientific.com

Source: Stainless India, Vol 19 No. 2



An Installation at Public Place in Delhi

Our Trademark: A "plus" Also In The Area Of Household Products



e report a statement coming from a leading company in the area of household products. "It is an undisputable fact that to give prominence to this logo means to convey, both to the retailer and to the end customer, the information that the manufacturing company has made the precise choice of fully complying with all the regulations in force concerning the use of materials destined to come into contact with food, and of purchasing them from certified suppliers". The company has been granted the permission to affix the INOV trademark on its price lists and catalogues, in order to provide "an additional information on quality: precise and state-of-the-art technology, guaranteed by a serious and professional association as Centro Inox".

Thanks to Davighi International (www.davighi-international.it)
Source: inossidabile.195



"DRAGON": The Legend Comes To Life

In the handwork shown in this article, stainless steel becomes a key element. Its dual function as a structural part and an aesthetic element, gives this sculpture of light a strong and impressive visual impact.

The chosen figure represents the mythical Chinese Dragon. The stainless steel structure is covered with Murano glass scales and LED strips arranged all along the contour of the sculpture.

The shape of the dragon is outlined on a super-

mirror finish, 1.5 mm thick, EN 1.4301 (AISI 304) stainless steel sheet. This wall lamp is 4 m. high, and 2,5 m wide. When the LED strips light up, as their colours are continuously changing, the Dragon seems to take on a life of its own, aided by the high reflecting capacity of the steel.

Thanks to Davighi International (www.davighi-international.it)
Source: inossidabile 195





Kad Steel Rolling Mills

Manufacturer and Exporter of High Quality Finish S.S. Sheets (Patta-Patti), Blanks, Circles.



Sheets / Patta



COIL



Sheets / Patta



Circles

WE OFFER S.S. SLITTED COILS, BLANKS AND CIRCLES FOR PIPES, SINK AND KITCHENWARE IN 201 & 304



Blanks

Manufacturing Range :-

- Grade - S.S - 200 (KS-1 to KS-7), S.S - 304
- Length - 2500mm +/- 200mm
- Width - Width up to 650mm
- Thickness - 0.30mm to 2mm
- Finish - Standard 2B, Mirror Finish / Satin Finish
- Product - Standard Patta, Blanks, Circles etc...

Applications:- Kitchenware, Flatware, Utensils, Gas Stove, Pipes, Hardware, Engineering, Furniture, etc....

Brand

SHIVAM™

SATYAM™

SUNDER™

SIKANDER™

KKK™

KING™

KSRM™

KAMAL™

- Factory 1: Plot : 3227, Phase IV, G.I.D.C. Vatva, Ahmedabad.
- Factory 2: Plot : 3401/5, Phase IV, G.I.D.C. Vatva, Ahmedabad.
- Tel.: +91-79-40085082, 83 Tel.: +91-79-25840088, 25840474
- Email: info@kadindia.com • Website: www.kadindia.com

- Sanjiv Kad 9099977880 Email: sanjiv@kadindia.com
- Sumnish Kad 9099977890 Email: sumnish@kadindia.com
- Sudhir Kad 9099977888 Email: sudhir@kadindia.com

JUNJHAR JI STEEL

JOB WORKER OF CIRCLE & PATTI CUTTING

KONIYA CIRCLE
42 mm to 6 inch

LAFI CIRCLE
4 inch to 9 inch



Factory: Plot # 202, Marudhar Kesari Nagar, Shobhawata Ki Dhani, Khome Ka Kunwa, Pal Road, Jodhpur (Rajasthan)
Mobile: +91-9214416820 • Email: junjharsteel@gmail.com

DESIGNING

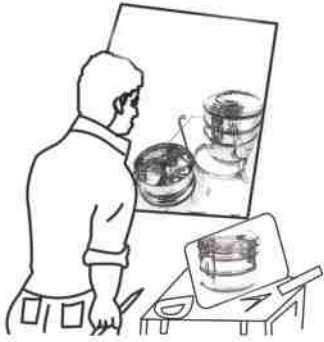

MAKING

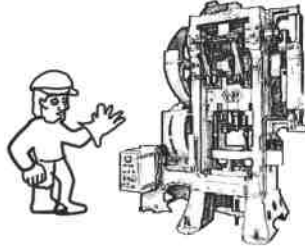

QUALITY



JOHNSON™
SINCE 1993 INDIA

"Experts in manufacturing of stainless steel tiffin carriers & kitchen utensils"

OUR RANGE OF PRODUCTS



Lucky Tiffin Carrier



Pressing Idly Cooker



Designer Cooker



Hand Crafted Idly Cooker



Travelling Carrier



Square Plate



Regular Food Pack



Antique Food Pack



Bulging Chocolate Dabba

Mercury Industries
Survey no : 628/2, 628/3, 2nd Cross Street,
Reddy Street, Madurametupalayam,
Puzhal, Chennai - 600 066
Tamil Nadu, South India
Landline : 044-26591266 / 044-35351266
Mob : +91 9444274266
Website : www.johnsonssindia.com
Mail id : reachus@johnsonssindia.com
Proprietor : S JOHN

OUR DESTINY



The Trusted Name In Kitchenware Since Last 25 Years

HOTLINE®

AN ISO 9001:2008 CERTIFIED COMPANY

Pressure Cooker, Pressure Pan
& Cookware

IS : 2347



WROUGHT
ALUMINIUM
CM/L-8480585
FOR PRESSURE
COOKER ONLY



Quality

That never ends..

Available in both (Inner & Outer) Lid Models From 1 to 30 Litres Capacity

Plot No. 12 Amin Estate. Behind Samrat Hotel, Sarkhej, Ahmedabad, Gujarat, India.

Email: gayatrimetalworks@gmail.com, web : www.gayatrimetalworks.com



Mfd. by :

GAYATRI METAL WORKS

M. 9825963080, 9979929398

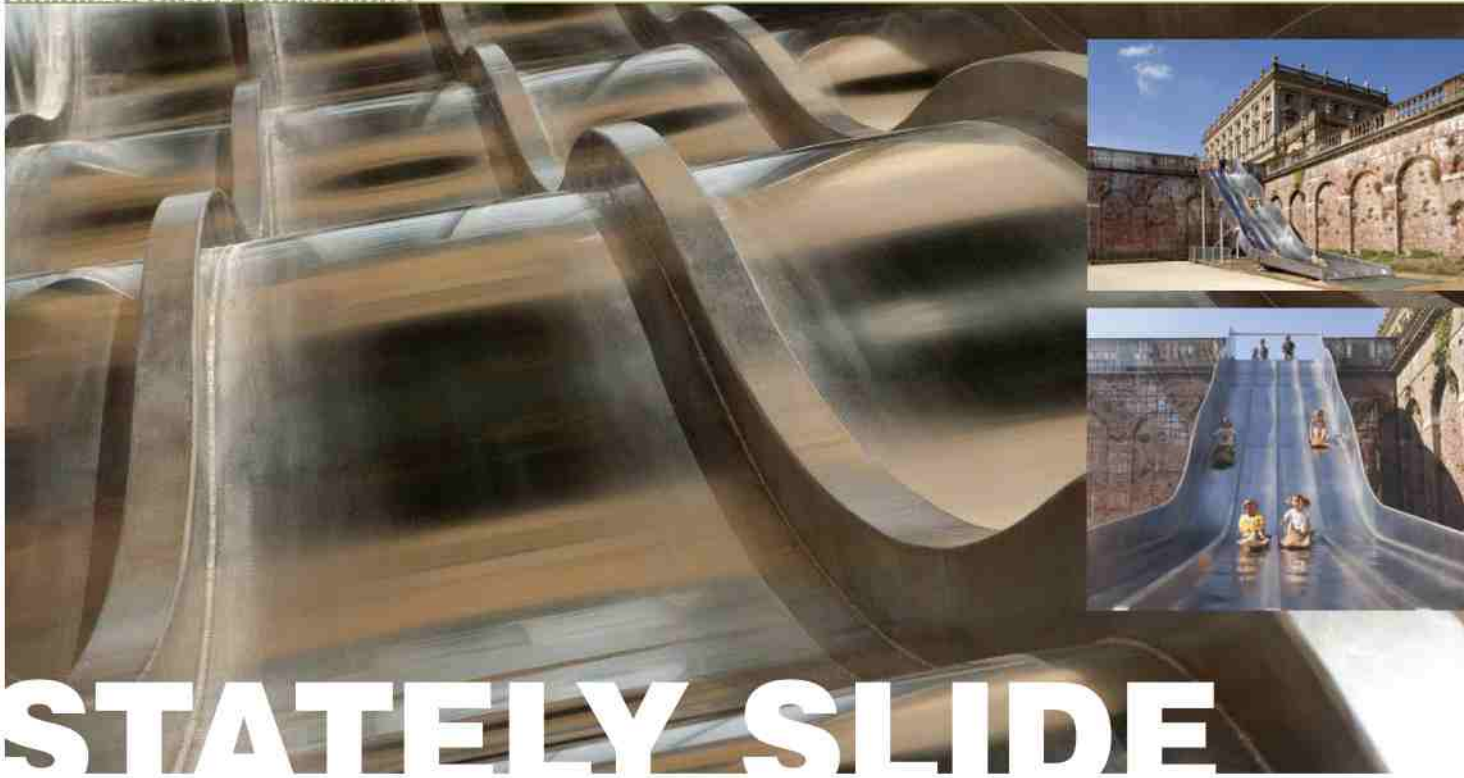

STATELY SLIDE



ormerly owned by the Anglo-American Astor family, Cliveden House is located about 40 kilometers to the west of London. Situated high above the River Thames and surrounded by wooded countryside, this stately home has a colourful history dating back to the 1600s. Today, the house and grounds are a major tourist venue—attracting visitors from all around the world. The estate now belongs to the National Trust and the house has been a luxury hotel since 1985.

To help fund restoration work to the large terrace which runs the length of the south side of the house, a temporary pay-to-ride slide was installed in 2013. From August 2013 until November 2014 the slide took youngsters, and the young at heart, from the terrace at

the back of Cliveden House down to the huge lawns and formal flower gardens.

The slide is made of nickel-containing Type 304 (UNS S30400) stainless steel in order to resist the weather and to always retain a clean, shiny appearance. The "wavy" slide is 7.5m high, 22m long and weighs about 3900kg. It is wide enough to accommodate four side-by-side tracks. The 2mm thick stainless steel was cut, formed and welded by Steel Line, U.K. with great care and attention to detail in order to minimize joints, eliminate rough edges and sharp corners and ensure a smooth, oxidation-free appearance.

Due to the restoration work on the terrace, the slide had to be moved. It easily endured this re-location.

Type 304 is a good material choice for playground equipment and outdoor furniture in most settings, as illustrated by this beautiful slide at Cliveden House. Seaside locations, or urban locations where road salt is used, would require more corrosion-resistant alloys such as nickel-containing Type 316 (UNS S31600) or Type 2205 (UNS S32205).

Type 304 is a good material choice for playground equipment and outdoor furniture in most settings, as illustrated by this beautiful slide at Cliveden House. Seaside locations, or urban locations where road salt is used, would require more corrosion-resistant alloys such as nickel-containing Type 316 (UNS S31600) or Type 2205 (UNS S32205).

Source: nickel, vol. 29, no. 3,

Stainless Steel Deep Drawing: A Complex Process Ensuring High Performances.

The deep drawing process, a typical stainless steel cold-forming method, allows to transform a flat sheet into a concave one keeping its thickness unchanged. The materials used for this process are traditional austenitic stainless steels, such as EN 1.4301 (AISI 304) and EN 1.4404 (AISI 316L) grades, of thicknesses ranging from 0.8 to 4.0 mm. More complex products require, instead, AISI 304DDQ (deep drawing quality) and EN 1.4303 (AISI 305) grades. Due the considerable plastic deformations it is submitted to, the material structure tends to harden, passing from an austenitic to a martensitic structure. This transition makes the material increasingly brittle, since it loses the characteristics of

ductility required by the process. Therefore, between the forming stages, a special heat treatment called "annealing" is carried out in a special oven, in which the elements to be treated are heated at a temperature exceeding 1020°. Then the parts are cooled. This process allows to reduce the presence of welds, thereby ensuring improved mechanical properties and better washability to the parts. The deep drawing process is used in several industrial applications and sectors, which include the catering, medical, and aeronautics industries, as well and the furniture and lighting industries.

Thanks to Davighi International (www.davighi-international.it)
Source: inossidabile 195

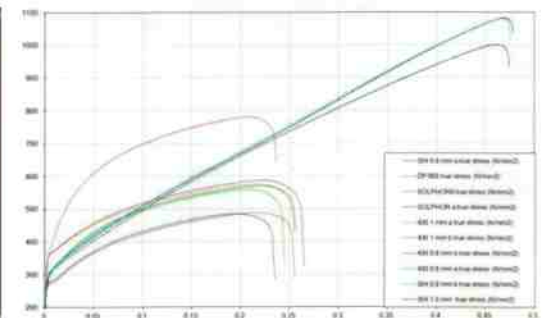

Stainless steel industry needs government support

Lower capacity utilisation and competition with Chinese imports is feared dent the country's stainless steel industry, industry players have said.

Currently, the stainless steel sector in the country operates at about 55 per cent capacity utilisation of the total installed capacity of 5 million tonnes per annum (mtpa).

"Stainless steel sector requires government support in the form of encouragement for exports and import restrictions on finished or semi-finished goods," said Ratan Jindal, chairman of Jindal Steel

during a media interaction here. Raising the issue of increasing dependence on imports and under-utilisation of production capacities, Jindal said, "Our imports of stainless steel have doubled in the last year"

Financial institutions have the bank exposure of about 30,000 crore to the sector. According to him, in recent years, stainless steel has found applications in areas other than the utensils.

"Stainless steel is used in consumer durables such as washing machines, fridges, ovens as well as entire kitchens. What we are aiming

is to increase India's per capita stainless steel consumption from 1.6 kg a year to that of some of the developed nations."

Europe has an average per capita stainless steel consumption of about 10 kg, China consumes about 6 kg, and Taiwan about 15 kg. "With Prime Minister Narendra Modi's vision of setting up 100 smart cities in the country, stainless steel consumption will get a boost. But for that policy support will also be required," he said.

Stainless Steel Production Reaches 30.9 Million Metric Tons in The First Nine Months of 2014

Stainless and heat-resisting melt shop steel production [000 metric tons]

The International Stainless Steel Forum (ISSF) has released figures for the first nine months of 2014 showing that stainless steel melt shop production increased by 8.9% year-on-year to 30.9 million metric tons (mmt). Production increased in all regions except for Central and Eastern Europe.

Region	Quarter			+/- % q-o-q	9 Months		+/- % y-o-y
	1/2014	2/2014	3/2014		2013	2014	
Western Europe/Africa	2,164	2,111	1,682	-20.3%	5,683	5,958	4.8%
Central/Eastern Europe	71	72	70	-2.3%	215	213	-1.0%
The Americas	670	717	711	-0.8%	1,824	2,097	15.0%
Asia (w/o China)	2,234	2,216	2,161	-2.5%	6,487	6,611	1.9%
China	5,084	5,603	5,336	-4.8%	14,176	16,022	13.0%
Total	10,223	10,718	9,960	-7.1%	28,385	30,900	8.9%

Source: International Stainless Steel Forum (ISSF) Published: 19/12/2014 Last modified: 19/12/2014

Stainless Steel in Agricultural Applications

The International Stainless Steel Forum (ISSF) has launched a new publication on Stainless Steel in Agricultural Applications

From a simple feeding pail to the most advanced fully robotised milking equipment, stainless steel is

found on farms in numerous applications, where it is an alternative to plastics, light metal and above all galvanised steel.

This new brochure from ISSF explains why stainless steel is used in agricultural applications and highlights

applications in fences, gates and partitions, feeding, watering, electrical and mechanical equipment, skin care, dairy farming, ancillary equipment and storage tanks for slurry and waste water.



Exploding Nickel Prices Driving The Stainless Steel Market Higher

Nickel prices at the time of writing, hovered around \$US30,000 per tonne. This suggests that alloy surcharges on stainless steel will remain at their current unprecedented high levels for at least two months.

For type 304 flat products, surcharges in October will be in excess of €1,900 per tonne in Europe and more than \$US2,500 per short ton in the US. Alloy surcharges have risen by more than 150 percent since January.

The LME price of nickel has doubled since March, and there is much controversy about the reasons for this. Users continue to claim that the nickel market is not under-supplied, and that the upsurge in prices is the result of speculation by financial investors. It is true that LME nickel

stocks have been extremely low. And this tends to support the opinion of those who say there is a structural shortage.

The hike in nickel prices is increasing the supply of scrap onto the market. World trade in stainless scrap has risen by more than 1 million tonnes over the last four years. But so far this is not having a dampening effect on the price of nickel.

Record levels of stainless steel production have certainly helped keep the figures high. Output of crude stainless in the first half of this year was almost 13.9 million tonnes – up by 6.5 percent year-on-year. Intriguingly, figures from the International Stainless Steel Forum reveal that most of this increase took place in the second quarter of the

year: output in April-June was 12.6 percent higher than in the same period a year earlier. This is likely to have continued into the third quarter – as the nickel prices headed up from \$US20,000 per tonne to \$US30,000 per tonne between June and August. There may also have been some of double booking, with buyers anxious to secure material in advance of September and October when the extremely elevated alloy surcharges came into effect.

There is certainly a danger of the market over-heating. Many of these duplicate orders may be cancelled. If the nickel price shows any sign of weakness, stainless buyers will be encouraged to hold off from placing new orders in the expectation of surcharges falling.

Source: MEPS - Stainless Steel Review

Jindal Stainless change in RTA

SL Stainless has decided to change its Registrar and Transfer Agent (RTA) from M/s. Abhipra Capital Limited to M/s. Link Intime India Private Limited, situated at 44 Community Center, 2nd Floor, Naraina Industrial Area, Phase I, Near PVR, Naraina, New Delhi - 110 028.

SL Stainless Ltd has informed BSE that the Sub Committee of Board of Directors of the Company in its meeting held on March 21, 2013 has decided to change its Registrar and Transfer Agent (RTA) from M/s. Abhipra Capital Limited to M/s. Link Intime India Private Limited, situated at 44 Community Center, 2nd Floor, Naraina Industrial Area, Phase I,

Near PVR, Naraina, New Delhi - 110 028 having registered office at C-13, Pannalal Silk Mills Compound, LBS Marg, Bhandup (West), Mumbai - 400 078, for both demat and physical registry work as well as for electronic connectivity with National Securities Depository Ltd. (NSDL) and Central Depository Services (India) Ltd. (CDSL). Source: BSE

Global Cold Rolled Coils Industry Report 2015

RESEARCHANDMARKETS
THE WORLD'S LARGEST MARKET RESEARCH STORE

(http://www.researchandmarkets.com/research/cndpcz/global_cold)

has announced the addition of the "Global Cold Rolled Coils Industry Report 2015" report to Their offering.



old Rolled Coils The Global Industry Report 2015 is a professional and in-depth study on the current state of the cold rolled coils industry. The report Provides a basic overview of the industry Including definitions, classifications, applications and industry chain structure. The cold rolled coils market analysis is provided for the international markets Including development trends, competitive landscape analysis, and key regions development status. Development policies and plans are so Discussed and Manufacturing Processes and cost structures Analyzed. Cold rolled coils industry import / export, consumption, supply and demand figures and cost price production value and gross margins are therefore provided. The report Focuses on twenty-nine industry players providing information retrieval as company profiles, product picture and specification, production capacity, price , cost, production value and contact information. Upstream raw materials and equipment and downstream demand analysis is therefore Carried out. The cold rolled coils industry development trends and marketing channels are Analyzed. Finally the feasibility of new investment projects are Assessed

and overall research Conclusions offered. With 211 tables and figures the report Provides key statistics on the state of the industry and is a valuable source of guidance and direction for companies and worth individuals interested in the market. Key Topics Covered: Chapter One Cold Rolled Coils Industry Overview Chapter Two Cold Rolled Coils International and China Market Analysis Chapter Three Cold Rolled Coil Technical Data and Manufacturing Plants Analysis Chapter Four Cold Rolled Coil by Regions By Technology By Applications Chapter Five Cold Rolled Coils Manufacturing Process and Cost Structure Cold Rolled Coil 2009-2014 Chapter Six Productions Supply Sales Demand Market Status and Forecast Cold Rolled Coil Chapter Seven Key Manufacturers Analysis Chapter Eight Up and Down Stream Industry Analysis Cold Rolled Coils Chapter Nine marketing channels Analysis Cold Rolled Coil Chapter Ten Industry Development Trend Cold Rolled Coils Chapter Eleven Industry Development Proposals Cold Rolled Coils Chapter Twelve New Project Investment Feasibility Analysis Chapter Thirteen Global Cold Rolled Coils and China Industry Research Conclusions

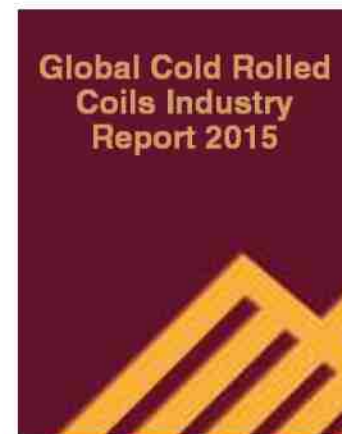

Companies Mentioned

AHMSA, Ansteel, Acerinox, ArcelorMittal, BAOSTEEL, BX Steel, Baogang Group, Beijing Shougang, HBIS, JFE Holdings, JSW Steel, Krakatau Steel, MMK, Masteel, NLMK, NSSMC, POSCO, SISG, SSAB, Shagang Group, TISCO, Tata Steel, ThyssenKrupp, United States Steel, Uttam Galva Steels, Valin Steel, WISCO, Xicheng Sanlian, Xinyu Iron & Steel

For more information visit
http://www.researchandmarkets.com/research/cndpcz/global_cold

Media Contact: Laura Wood , +
353-1-481-1716,
press@researchandmarkets.net

Chinese Steel Losing Some Of Its Competitive Edge - Meps



K steel industry analysts, MEPS, reports that, in October, a profound change developed in the relationship between Chinese export steel prices and domestic selling values in the rest of the world.

According to the company's latest report, CHINA STEEL REVIEW, Chinese exporters lowered their steel prices last month for most

rolled steel products. The median reduction was US\$13 per tonne. However, average domestic selling figures in North America decreased by US\$17 per tonne in the same period. Local average steel selling values in the European Union decreased by US\$27 per tonne and those in East Asia fell by US\$35 in October.

The differential between Chinese export delivered prices and domestic selling values is a key item in the decision making process to purchase from China. Improved quality from Chinese mills has also, however, played its part.

It is possible that, in the near future, China's steel products could become less attractive to buyers in

the industrialised countries of the world, particularly, if their steel market conditions deteriorate further.

Total Chinese exports of all steel products, including tubes and semi-finished goods, totalled 51.54 million tonnes in the first eight months of this year. This represents an increase of 36 percent on the outturn in 2013. Foreign supplies of the nine finished rolled steel mill products, which had not undergone further processing, were recorded at

44.2 million tonnes - up by almost 45 percent in the same period.

The most popular finished rolled steel products for export remain hot rolled coil, wire rod and merchant bar. Statistics for the latter item are dubious, because it is widely believed that a proportion of billet sales were recorded as merchant bar in the official documentation to avoid export taxes. The tonnage sold under the banner of merchant bar has increased by approximately 75 percent so far this year. This

figure is almost double the average increase for all the other products.

The Chinese mills were able to lift their sales volumes of rolled steel products because of their ability to compete on price with other manufacturers around the world. This developed despite the cost of freight and extended period of time for delivery. A change to this situation may be on the horizon. Chinese steel exports may decline in 2015. Watch this space.

Source: MEPS China Steel Review - October Edition

China's stainless steel market stabilises; downward pressure remains



China's domestic stainless market showed signs of stabilising this week on rising nickel prices, although participants expect further downward pressure as mills maintain output levels despite slack demand.

Prices for benchmark 304 cold rolled coil were in the range of 15,600-15,900 yuan (\$2,540-2,589) per tonne including VAT in the major Wuxi market on Thursday January 8 compared with 15,500-16,000 yuan (\$2,520-2,601) per tonne on Thursday December 25.

"Nickel prices have started to recover, which means at least that stainless steel prices will stop sliding," a trader based in Wuxi said.

The three-month London Metal Exchange nickel contract ended official trading on Wednesday January 7 at \$15,530-15,540 per tonne, up \$510-515 per tonne from a week ago.

However, the boost may have come too late, another trader warned, as buyers are now reducing purchase volumes ahead of the week-long Chinese New Year holiday.

Despite the drop off in demand, steelmakers are not scheduling any maintenance at plants to reduce supply to the market.

"Mills are not loosening their grip on production despite cashflow concerns," a distributor in eastern China said.

Once they run out of cash, they are likely to sell material cheaply to generate funds, he added, which will put pressure on spot prices.

Steel First sister publication Metal Bulletin assessed spot prices for high-grade NPI (Ni 10-15%) at 1,090-1,100 yuan (\$177-179) per nickel unit on Tuesday January 6, down 40-50 yuan (\$7-8) per nickel unit from last week.

Jiangsu-based Zhangjiagang Pohang's purchase price for high-grade NPI (Ni 10-15%) is at 1,090 yuan (\$177) per nickel unit this week, unchanged for the past two weeks.

Import duty wont impact pricing much: Jindal Stainless



The government has imposed 20 percent safeguard duty on imports of a certain variety of stainless steel from China to protect domestic players. In an interview to CNBC-TV18, Ramesh Nair, president & ED, Jindal Stainless informed that it is for a provisional period of 200 days on

hot-rolled coils of stainless steel and he is happy with it.

"This would actually help the sentiment of the market and also stem the import to a certain extent on hot-rolled side"

RAMESH NAIR
president & ED Jindal Stainless

Read more at:
<http://www.moneycontrol.com/>

Sony hops on fashion train with stainless steel SmartWatch 3

new stainless steel holder turns flagship wearable into fashion item

Sony has introduced a new, sleeker holder for the SmartWatch 3 at CES 2015, bringing it into line with the fashion trend that is starting to change the face of the wearables market.

When it was launched in September last year, the SmartWatch 3 came with a range of four interchangeable rubber wristbands, sold at £20 each, and was solidly marketed as a fitness wearable.

However, the change in presentation with the new stainless steel strap, which Sony describes as matching "contemporary with timeless aestheticism for a premium look and feel", could bring the SmartWatch 3, and its successors, to a new market.

Sony is by no means the first company to go down the fashion wearable route. The Motorola Moto 360, with its leather strap, is clearly a lifestyle item as much as a geeky one, while the META M1, Creoir Ibis and Intel MICA are all specifically marketed as luxury items.

Additionally, when it finally launches later this year, the Apple Watch will also be available with a stainless steel strap.

New look aside, there has been no change to the SmartWatch 3 in terms of specs. The computing module of the device still has a 1.6in, 320 x 320 display with transfective technology, built-in GPS as standard, and an IP68 certification, meaning it can be submerged in water for 30 minutes and is completely sealed against dust.



It also still has 4GB of flash memory, NFC capability (although this has no real use at the moment), just under 48 hours of battery life and convenient charging via micro-USB. The core unit is also removable, meaning it can be interchanged with the original rubber straps for SmartWatch 3, which are available for about £20, as well.

The stainless steel SmartWatch 3 will be available from February.

UK stainless scrap prices rise further on the back of nickel

Inter-merchant prices for stainless steel scrap in the UK rose by £20 (\$31) per tonne for the third consecutive week after the price of nickel jumped by about \$500 week-on-week, sources told Metal Bulletin sister publication Steel First on Friday December 5.

The three-month official daily bid/offer spread for nickel on the London Metal Exchange closed at \$16,870-16,875 on Friday, up by \$475-520 week-on-week. Steel First's price assessment for domestic 18/8 stainless steel scrap solids was £860-880 (\$1,349-1,380)

per tonne delivered to the scrapyards. Stainless steel turnings in the UK are priced at an average 85%

Read more: www.metalbulletin.com

East Asian stainless steel market still seeing poor demand

the East Asian stainless steel market continued to suffer from slow buying this week, although prices for nickel have rebounded.

Metal Bulletin sister publication

Steel First assessed prices for February shipments of benchmark 304 stainless 2mm cold rolled coil at \$2,320-2,500 per tonne cif East Asian port on Friday January 9, widening downwards by \$40 per

tonne from last week's assessment. European Central Bank president Mario Draghi has hinted of a growing likelihood...

Read more: www.metalbulletin.com

ISSDA wary about rising stainless steel imports

Indian domestic stainless steel makers are worried about the rising imports from China, Japan and Korea, as capacity utilization falls to around 50-55 per cent, the Indian Stainless Steel Development Association (ISSDA) said.

While the country has an installed capacity of around 5 million tonnes per annum (mtpa), only about 2.4-2.8 mtpa of stainless steel was produced. However, India remains the world's third largest producer.

"With growing imports from China,

Japan and Korea, Indian stainless steel makers are in a fix. We will continue to bleed until basic Customs duty on all the key raw materials in India are reduced to zero to ensure a level playing field," Mr. N.C. Mathur, President of ISSDA, pointed out.

Expo 2015 the proposals of Centro Inox

Centro Inox subscribed the "First international call for ideas aimed at developing the cultural program of the Pavillion of Civil Society at EXPO Milano 2015" in order to participate in the project "Exploding energies to change the world" with three proposals:

A stand during the week June 8-14, 2015 for the launch of the

"Educational program for the promotion of the technical and market knowledge of stainless steels",

A half-day meeting, on June 10, 2015 focused on "Production and conservation of foodstuffs: the stainless steel hygienic chain",

A half-day meeting, on September 24, 2015, focused on "Stainless steel. Eco-sustainability and recyclability".

Additional information: Centro Inox, phone +39 02 86450559/69, eventi@centroinox.it, www.centroinox.it, / Fondazione Cascina Triulza, www.fondazionetriulza.org

India to remain world's fourth largest steel maker this year

NEW DELHI: India will remain the world's fourth largest steel maker this year even as its production growth outpaced the global average in the first 11 months, World Steel Association (WSA) data showed.

India has produced 76.19 million tonnes (MT) steel in the January-November period compared to 74.37 MT during the same period last year, clocking 2.4 per cent growth and positioned itself again at the fourth slot.

Global steel production during the period grew by 1.8 per cent to 1,497.75 MT, compared to 1,471.44 MT in the same period last year.

Despite dip in production in some previous months, China has been world's top steel producer in the first

eleven months of current year, with output of around 650 MT.

Japan produced 101.66 MT during the 11 months, clocking a 0.4 per cent growth over 101.25 MT in the year-ago period.

Production in the US grew by 1.5 per cent in the first 11 months of the year to 80.95 MT from 79.75 MT a year ago. Though the gap in production between India and the US is not wide as of now, that is unlikely to change the order as the US produced more steel even in November.

"India may topple the US next year as a lot of capacity is being added here, and a good part of that is coming on stream in the next couple of months, from around 101 MT











now," according to an industry official.

The ranking among the top four steel producers remain the same for the last four years.

India produced 6.89 million tonnes (MT) steel in November compared to 6.57 MT a year ago. During the month, world's steel output was 130.52 MT, as against 130.42 MT a year earlier. Steel production in China declined yet again during the month by 0.2 per cent to 63.30 MT.

During November, Japan produced 9.17 MT steel, the US 7.2 MT, South Korea 5.91 MT and Russia 5.84 MT.

Source: www.economictimes.com

			
Pawali	Storage Box	Balti	Fatka Balti
			
Akhand Balti	Catering Tub	Sada Khumcha	Star Khumcha
			
MP Beading Khumcha			Dustbin
			
Patti Beading Parat & Patti Plain Parat			Beading Mattar Parat
			
UP Tasla	Bachar	Matki	Malai Matki
			
Tops	Soupe Pan	Katori	Wati

Mehta Enterprises

Factory : E-352, 1st Phase, Mini Growth Center, Sangaria, Jodhpur - 342005
 Contact Person : Ramanlal Mehta - 9460775079, Dhanpal Mehta - 9929130222, Mukesh Mehta - 96607 78748
 Email: sales@luckystainlesssteel.com • Web: www.luckystainlesssteel.com, www.mehtaenterprises.in





Celebrating Happiness ...

SRM GROUP
Jodhpur

Ab Aap Ke Kitchen Mai ...

Patta-Patti • Utensils • Box Pack Gift Series

Tops



Parat



Pans



Dabba



Masala Dabba



Rangilo Steel

57 pcs
Dinner
Set



Many More.....

For Stainless Steel PATTA-PATTI Rolling Sheets :

KAILASH OJHA

SRM ALLOYS PRIVATE LIMITED

E-75, Marudhar Industrial Estate, Basni Phase - 2nd, Jodhpur (Rajasthan)

Telephone : +91-291-2741896, 9610380000, 9352047567

Fax : +91-291-2746896

Email Id : srmalloy@rediffmail.com, info@groupsr.com

Website : www.groupsr.com

For Utensils and Gift Items :

RAJESH OJHA

Shri Ram Utensils Industries

Plot No. 1 & 2, Saboo Industrial Estate, Tanawara Fatta,
Salawas Road, Jodhpur (Rajasthan)

Telephone : +91-9828074607 9352047580

Fax : +91-291-2746896

Email id : sru2012@rediffmail.com, sales@chikkumikku.com

Website : www.Shrimangalmurti.com

www.Chikkumikku.com

India's widest range of more than
2,000 quality products under
one roof.



RATNA[®]

Kitchenware • Dinnerware • Tableware
Banaye cooking aasaan !



- Wide range of stylish kitchenware solutions.
- Easy availability.
- High-quality kitchenware, Dinnerware, Tableware.
- Value-for-money.
- Life-Time warranty products.



Welcome to the world of Ratna Home Products Pvt. Ltd., a company driven to deliver Wide range of innovative products, cutting-edge quality and value-for-money kitchenware and stainless steel ware. Our passion to consistently deliver highest grade products has earned us the trust of our esteemed clientele and partners. We strive to become an inseparable ingredient of the modern lifestyle and partner you on the path to great success.

Distributors, Merchant Exporters, Corporate Gifting, Hotels, Hospitals, Government & Institutional Enquiries are welcomed.



INDINOX2015

Exhibitor **Directory**



24 25 26 27
SAT SUN MON TUE

JANUARY, 2015

Company Name : **AAKAR PIPES AND METAL PRIVATE**
 Address : ADMINISTRATIVE OFFICE & SHOP: 134 A, SHIVAJI MARKET, NAGAR NIGAM ROAD,
 City : INDORE
 Contact Person : NITIN JAIN
 Designation : Director
 Telephone No. : 0731 2430038 / 2903503
 Cell No. : 9826620125/ 9993895507
 Email : aakarpipes@gmail.com
 Website : www.aakarpipes.com
 Brand Name : A1
 Business Type : MANUFACTURER
 Products Details : SS Pipes & TUBES
 Stall No. : **Hall No. 3 / Stall 79**

Company Name : **AHMEDABAD MATELWARE MANUFACTURERS ASSOCIATION**
 Address : C/O MAHALAXMI METAL UDHYOG 132, GVMM Odhav
 City : AHMEDABAD-382415
 Contact Person : Jabar Singh Rajput
 Position : PRESIDENT
 Telephone No. : 079-22900680,
 Cell No. : 9376145991
 Email : meerametalind@gmail.com

Company Name : **AARDISONS KITCHENWARE/ POPULAR PRODUCTS**
 Address : 21/30, SAMRAT IND. AREA, B/H. S.T. WORKSHOP, GONDAL ROAD
 City : Rajkot
 Contact Person : Aasish Patel
 Designation : Owner
 Telephone No. : 9426250894
 Cell No. : 0281-2360276
 Email : ashiz2008@gmail.com
 Website : www.aardisonskitchenware.com
 Brand Name : Popular, aardisons
 Business Type : Manufacture
 Products Details : All Kichenwere items
 Stall No. : **Hall No.1 / Booth No. 77**

Company Name : **AARON ALLOYS**
 Address : 4, Ashish Industrial Estate, near Kewal kanta, Rakhial, Ahmedabad - 380023
 City : Ahmedabad
 Contact Person : ANIL JAIN
 Designation : OWNER
 Telephone No. : 91 79 B265210000, 30417730
 Fax No. : N A
 Cell No. : 9444236374, 9710290000
 Email : aaronalloys@yahoo.com
 Website : N A
 Brand Name : AARON ALLOYS
 Business Type : TRADER
 Products Details : S. S. ROUND BAR, S.S. PIPES, HEX
 Stall No. : **Hall No. 3 / Stall 67**

Company Name : **ACID LOOP**
 Address : The Energy and Resources Institute IHC Complex, Lodi Road New Delhi 110003, India
 COUNTRY : INDIA
 City : NEW DELHI
 Contact Person : Mr. Rajeev Pillai / Dr. Malini Balakrishnan
 Telephone No. : 011 24682100
 Email : office@adelphi.de, workshop@acidloop.in
 Website : http://acidloop.in/
 Brand Name : ACID LOOP

Company Name : **ACTIONWARE INDIA PVT. LTD.**
 Address : VILLAGE - DHOLARA, N/R - KANGASHIYALI VILLAGE,

GONDAL ROAD, RAJKOT - 360 022.
 City : RAJKOT
 Contact Person : MR. KISHAN MANVAR
 Designation : VICE PRESIDENT (MARKETING)
 Telephone No. : 91-2827-293552/1
 Fax No. : -
 Cell No. : 91-940 930 9015
 Email : INFO@ACTIONWARE.IN
 Website : WWW.ACTIONWARE.IN
 Brand Name : ACTIONWARE
 Business Type : MANUFACTURER / EXPORTER / SUPPLIER
 Products Details : KITCHENWARE / HOUSEWARE / HOUSE CLEANINGWARE
 Stall No. : **HALL NO 1 / STALL NO 29**

Company Name : **ADVENT ENTERPRISES PVT LTD**
 Address : 603 MAKER CHAMBER V, NARIMAN POINT, MUMBAI - 400021
 City : MUMBAI
 Contact Person : Mr. Shailesh Agarwal / Mr. Udhav Murarka
 Designation : DIRECTOR
 Telephone No. : CODE : 022 TEL : 22820169 / 22840417
 Fax No. : FAX : 022-22840417
 Cell No. : 09821017017/ 09820010465
 Email : shaildeep@gmail.com / udhavmurarka4@gmail.com
 Website : www.demont.co.in / www.indiamart.com/demont
 Brand Name : DEMONT
 Business Type : Manufacturer , trader, importer , exporter
 Products Details : kitchen appliances
 Stall No. : **Stall No. 18 Houseware Hall 1**

Company Name : **AHMEDABAD MATELWARE MANUFACTURERS ASSOCIATION**
 Address : C/O MAHALAXMI METAL UDHYOG 132, GVMM Odhav
 City : AHMEDABAD-382415
 Contact Person : Jabar Singh Rajput
 Position / Designation : PRESIDENT
 Telephone No. : 079-22900680,
 Cell No. : 9376145991
 Email : meerametalind@gmail.com

Company Name : **AGILE MACHINERIES PVT LTD**
 Address : 24, SILVER ESTATE, NEAR S KUMAR INDUSTRIES, SOLA-SANTEJ ROAD,
 City : RAKANPUR, GANDHINAGAR
 Contact Person : YAGNESH ZINZUVADIYA
 Designation : DIRECTOR
 Telephone No. : 2764 268399
 Fax No. : -
 Cell No. : 90999 23045
 Email : MARKETING@AGILETECHWORLD.COM

Website : WWW.AGILETECHWORLD.CO M
 Brand Name : AGILE LASER MARKING
 Business Type : MANUFACTURER
 Products Details : LASER MARKING MACHINE , LASER ENGRAVING MACHINE, AUTOMATION
 Stall No. : **STALL - 86 , HALL - 2**

Company Name : **AJANTA STEELS**
 Address : 31, C.P TANK ROAD, MUMBAI-400004
 City : MUMBAI-400004
 Contact Person : MR. RAMESH SANGHVI AND MR. NARESH SHAH

Designation : PARTNER
 Telephone No. : 22424511/22428551/66394300/ 66393656
 Fax No. : 22421736
 Cell No. : 9821116816/ 9821423240
 Email : info@ajantafoil.com, ramesh@ajantafoil.com, naresh@ajantafoil.com, ajantafoil@vsnl.net
 Website : www.ajantafoil.com
 Business Type : manufactueres and supplier
 Products Details : Stainless steels strips, coil, shims, sheet, patta, pati
 Stall No. : **STALL NO- 68 AND HALL NO- 3**

Company Name : **ALANG AUTO & GENERAL ENGINEERING CO. PVT. LTD**
 Address : CM-458, "RUKMANI KUNJ", NR, VIRANI SCHOOL, KALVIBID, BHAVNAGAR. PIN. 364002, GUJARAT, INDIA.
 City : Mr. UDAI AGARWAL
 Contact Person : DIRECTOR
 Designation : Office. 91-278-2560 473, 2569 538.
 Telephone No. : 91- 278- 2563 837
 Fax No. : 91- 982520 5604
 Cell No. : alangauto@yahoo.com , director@alangauto.com
 Email : www.alangauto.com
 Website : ALANG AUTO
 Brand Name : Import - Export, Trading, Ship Recycling.
 Business Type : Mild Steel Scrap, Alloy Steel Scrap, Stainless Steel Scrap, Copper - Nickal Scrap , Ni-Al-Bronz Propeller Materials
 Products Details : **Hall No. 3 / Booth No. 6**
 Stall No. :

Company Name : **AMARDEEP FURNITURES**
 Address : A/103, Sanjay Building No. 5, Mittal Estate, Andheri Kurla Road, Andheri East, Marol Naka,
 City : MUMBAI-400059
 Contact Person : Saroj
 Designation : PROPRIETORS
 Telephone No. : 022-4291 7777/ 4005 7864
 Fax No. : 022-4291 7700
 Cell No. : 9920079963 / 9821812901
 Email : ami@amardeepchair.com, info@amardeepchairs.net
 Website : www.amardeepchair.com
 Brand Name : AMARDEEP CHAIR
 Business Type : MANUFACTURERS
 Products Details : HOME & HOUSE FURNITURE
 Stall No. : **Hall No. 2, / Booth 83**

Company Name : **AMARDEEP UTENSILS INDIA PVT. LTD.**
 Address : K-5, Vikash Udyog Nagar, Nr. Telephone Exchange, Hanuman Mandir Road,
 City : BHAYANDER (E) (MHRSTR)-401105
 Contact Person : Mr. Dharmendra Bhai Shah
 Designation : Owner
 Telephone No. : 022-28144411, 22, 33
 Cell No. : 9821017292
 Email : kjshah9999@gmail.com
 Website : www.dharasteel.com
 Brand Name : DHARA
 Business Type : MANUFACTURERS & EXPORTER
 Products Details : pressing & spinning Of Stainless Steel House Hold Appliances Industrial works
 Stall No. : **Hall No. 1 / Booth No. 84**

Company Name : **AMAZON BURSH CO.**
 Address : RZ-13, Mahindra Park, Pankha Road
 City : NEW DELHI

Contact Person : Mr. Saurabh Jain
 Designation : PROPRIETORS
 Telephone No. : 011-85639332
 Cell No. : 9810131371, 9871347575
 Email : contact@ocspl.com, sj@scrubshine.com
 Website : www.scrubshine.com
 Brand Name : AMAZON - SCRUB, POLISHING COMPOUNDS
 Business Type : Manufacturers
 Products Details : Matt Polishing wheel, Cotton Polishing wheel, Coir Fibre Polishing wheel, Abrasive Rolls, Abrasive belts / Emery Belts, Polishing Pads, Flap Disc.
 Stall No. : **Hall No. 2, / Booth 3**

Company Name : **ANCHOR EXPORTS**
 Address : Anchor Appliances, 322 Mint Street, Park Town
 City : CHENNAI-600003
 Contact Person : J.Kishore Jain, Suresh Jain
 Designation : PROPRIETORS
 Telephone No. : 044-25350203
 Cell No. : 9444058822, 9444043367
 Email : Sanchor99@gmail.com
 Brand Name : ANCHOR APPLIANCES
 Business Type : Manufacturers
 Products Details : Kitchen Wares & Hot Pots
 Stall No. : **Hall No.1, / Booth 64**

Company Name : **Anil Metal's (Kanchi)**
 Address : E-8,Saistar Estate,Navghar cross road no.3,Opp meeraJ bakery,Bhayander(East)
 City : Mumbai
 Contact Person : Anil.PNagda
 Designation : Propreitor
 Telephone No. : 28040870
 Cell No. : 9324340870
 Email : Anil.Kanchi2011@Gmail.com
 Brand Name : Kanchi
 Business Type : Manufacturer/Trader
 Products Details : Stainless steel utensils
 Stall No. : **Hall No. 1 / Stall 55**

Company Name : **ANKUR INDUSTRIES**
 Address : G-1105 GIDC METODA (LODHKA) RAJKOT
 City : METODA (RAJKOT)
 Contact Person : MR.BHAVIN GHELANI (2)MANISH GHELANI
 Designation : PARTNER
 Telephone No. : 2827287252
 Cell No. : 9374100792(2), 9000591390, 9824483409
 Email : bhavinghelani@gmail.com
 Website : www.ankurkitchenwares.com
 Brand Name : ANKUR
 Business Type : MANUFACTURERS/EXPORTE R

Products Details : KITCHENWARE
 Stall No. : **Hall No. 1 / Stall No. 10**

Company Name : **ARIHANT METAL CORPORATION**
 Address : 48, RANGWALA BUILDING, ISLAMPURA STREET, MUMBAI-400004(INDIA)
 TEL: +91-22-6651 8600 / 6659 5002
 CELL: +91-98200 10510
 CELL: +91-99870 05859
 City : MUMBAI
 Contact Person : MR.JITENDRA SANGHVI
 Designation : MANAGING DIRECTOR
 Telephone No. : 9820010510
 Cell No. : 9987005859
 Email : stainlessexports14@yahoo.com
 Website : www.arihantmetal.in
 Brand Name : STAINLESS STEEL PRODUCTS
 Business Type : IMPORTER
 Products Details : DEALING IN STAINLESS STEEL PRODUCTS (

SHEETS/COILS/PIPE/PLATES) ETC
 Stall No. : **STALL NO.56 / HALL NO.3**

Company Name : **ARVIND ANTICOR LTD**
 Address : SURVEY NO. 563/1,PHASE IV, VATVA, G.I.D.C. RAMWADI OPP. HANUMAN TEMPLE, ON MAHEMDAVAD ROAD, AHMEDABAD
 City : AHMEDABAD
 Contact Person : MR. BIPIN CHANDRA PAREKH
 Designation : Director
 Telephone No. : 079-25840689
 Cell No. : 9374523404
 Email : info@picklingplant.com, info@arvindanticore.com
 Website : www.picklingplant.com, www.arvindanticore.com
 Brand Name : Anticore
 Business Type : Mfrs
 Products Details : Proces Tank
 Stall No. : **Hall 3 / Stall 64**

Company Name : **ASHAPURA INDUSTRIES**
 Address : C/23, Maruti Ind, Estate, Nr. Kiran Bus Stop. GIDC, Vatva
 City : AHMEDABAD (GUJRAT)-382445
 Contact Person : Shankarlal D. Suthar, R.S. Suthar
 Designation : PROPRIETORS
 Telephone No. : 079-40087267
 Cell No. : 9428114489, 9925034489, 9727504848, 9426374090
 Email : info@ashapuraindustries.com
 Website : www.ashapuraindustries.com
 Business Type : MANUFACTURERS & EXPORTER
 Products Details : Utensils, Rolling mill & Other Machinery
 Stall No. : **Hall No. 2, / Booth 54**

Company Name : **AVON ENTERPRISES**
 Address : C-7/216, YAMUNA VIHAR, SHAHDARA
 City : DELHI-110053
 Contact Person : SAURABH TAYAL
 Designation : PROPRIETOR
 Telephone No. : 9811647431
 Cell No. : 9910047431
 Email : priyapolishingworld@gmail.com, priyapolish@gmail.com, www.priyapolishingworld.com
 Website : www.priyapolishingworld.com
 Brand Name : PRIYA
 Business Type : MANUFACTURER/EXPORTER
 Products Details : METAL POLISH
 Stall No. : **STALL NO. 71, HALL NO. 3**

Company Name : **BALAJI INDUSTRIES**
 Address : KAILASH INDUSTRIAL AREA, STREET NO.3,SWATI PARK MAIN ROAD,RING ROAD BYPASS
 City : RAJKOT
 Contact Person : MR.PARESHBHAI RAIYANI
 Designation : PARTNER
 Telephone No. : 0281 645 2755
 Cell No. : 98250 78985
 Email : info@capitalkitchenware.com
 Website : www.capitalkitchenware.com
 Brand Name : CAPITAL
 Business Type : MANUFACTURERS
 Products Details : KITCHENWARE
 Stall No. : **STALL NO.25 HALL NO.1**

Company Name : **BANSAL WIRE INDUSTRIES LIMITED**
 Address : F-3, MAIN ROAD, SHASTRI NAGAR, NEW DELHI-110052
 City : NEW DELHI
 Contact Person : SACHIN SIDHAR
 Designation : AGM - MARKETING
 Telephone No. : 011-23651891
 Fax No. : 011-23651890

Cell No. : 9871697613
 Email : sachin@bansalwire.com
 Website : www.bansalwire.com
 Brand Name : BANSAL WIRE INDUSTRIES LIMITED

Business Type : MANUFACTURERS
 Products Details : STAINLESS STEEL WIRES & B.BAR, G.I WIRE, HIGH/LOW CARBON STEEL WIRES, CABLE ARMOURING WIRES & STRIPS.

Stall No. : **STALL NO = 54, HALL NO-3**

Company Name : **BENGANI UDYOG (P) LTD.**
 Address : 514-515, KATHAWADA, GIDC PHASE 2, ROAD NO.13. GIDC , AHMEDABAD
 City : AHMEDABAD
 Contact Person : SURENDRAJI
 Designation : MD
 Telephone No. : 079-2405993
 Cell No. : 9374024670
 Email : INFO@BENGANIUTENSILS.COM

Brand Name : BENGANI
 Business Type : MFRS
 Products Details : SS UTENSILS
 Stall No. : **Hall 3 / Stall 58**

Company Name : **BHAGWAN SHRI STRIPS PVT LTD**
 Address : JB STEEL , A-46, WAZIRPUR
 City : DELHI-110052
 Contact Person : Mr. Sanjay Jain, Mr. Abhishek Jain
 Designation : PROPRIETORS
 Cell No. : 9810031328, 9711460680
 Email : sjainsteel@yahoo.com, abhishek.jain1993@yahoo.in

Business Type : MANUFACTURERS
 Products Details : Stainless Steel Circle, Coils, Utensils, Wires
 Stall No. : **Hall No. 3, / Booth 83**

Company Name : **BHARAT STEEL YARD PRIVATE LIMITED**
 Address : 12, SKM HOUSE , KHETWAI 6TH LANE
 City : MUMBAI - 400 004
 Contact Person : Shailesh shah /Dinesh shah
 Position / Designation : PROPRIETORS

Telephone No. : 022 6116222 (10 LINE)
 Fax No. : 022 61164444
 Email : sales@bsypl.com
 Website : www.bsypl.com
 Business Type : TRADERS
 Products Details : STOCKIST OF STAINLESS STEEL COIL /SHEET / WIRE / BRIGHT BAR AUTHORISED STOCKIST OF : TATA WIRON , JINDAL STEEL, VIRAJ STEEL

Stall No. : **Hall No. 3, / Booth 36**

Company Name : **BHALARIA METAL CRAFT PVT. LTD**
 Address : Raj Asman, Ground Floor, Swami Satyanandji Maharaj Marg, Off Radhaswami Satsang Road, BHAYANDER (WEST) DIST. THANE - 401101
 City : THANE
 Contact Person : NEHAL GANATRA
 Designation : MARKETING MANAGER
 Telephone No. : +91-22-28198226
 Fax No. : +91-22-28198227
 Cell No. : +91-9920021845
 Email : sale@bhalariametal.com
 Website : www.bhalariametal.com/www.bhalaria.com

Brand Name : Bhalaria
 Business Type : MANUFACTURE/EXPORTER

Products Details : Stainless Steel products for Houseware & Food Service Industry viz. Bar Accessories, Restaurant supplies, Kitchenware, Fabricated products, Wire products, Bake ware, Aluminum products, Bathroom Accessories, Office Accessories etc. We specialize in OEM products.

Stall No. : **Hall 1, Booth 12**

Company Name : **BHATT BROS**
Address : NIDC Estate, Near Trumac Engineering Company, Lambha AHMEDABAD-380026
City : AHMEDABAD-380026
Contact Person : Mr. Kankesh Bhatt, Mr. Udayan Bhatt,

Designation : Director
Cell No. : 8042969551
Email : info@bhattbros.com
Website : www.bhattbros.com
Brand Name : BHATT BROS
Business Type : Manufacturers
Products Details : Textile Machinery Spares, Textile Machinery, Integrated Sheet Metal, Integrated Sheet Metal Precision Sheet Metal Components

Stall No. : **Hall No. 2 / Booth No. 78**

Company Name : **BHAWANI KITCHENWARE PVT. LTD**

Address : B-2, Hatkesh Udyog Nagar, Mira-Bhayandar Road, Behind Hundai & Maruti CAR Showroom, Mira Road (E)
City : MUMBAI-401107
Contact Person : Mr. Hansraj Patel, Mr. Mahesh H. Patel, Mr. Mahender Patel

Designation : Directors
Telephon No. : 022 28553133, 28104006, 28131434.
Fax No. : 022 28103139.
Cell No. : 9821086664, 9819 566842, 9930341434.
Email : info@bhawanikitchenware.com, sales@bhawanikitchenware.com

Website : www.bhawanikitchenware.com
Brand Name : "Bhawani" (The King of Kitchenware...)

Business Type : Manufacturer & Exporter of Stainless Steel Utensils.
Products Details : Induction based & Capsulated based Pots, Pans, Wok, German Cookare Sets, Italian Sets, Trio Supreme Sets, Insulated Food Warmer, All types of new Trays, Kitchenware, Tabelware & Hotelware.

Stall No. : **Hall No. 4 / Booth No. 17**

Company Name : BHUTAJI INDUSTRIES
Address : C/110/1 GIDC., Ambikanagar, Road, Odhav,
City : AHMEDABAD (GUJRAT)-382415
Contact Person : Mr. Bhawar Jain, Mr. Suresh Jain, Mr. Chirag Jain

Designation : PROPRIETORS
Telephon No. : 079-22891682
Cell No. : 9426087464
Email : rchiragb@yahoo.co.in
Business Type : MANUFACTURERS
Products Details : Stainless Steel Utensil, Housewaer, Vali, Baket, etc.
Stall No. : **Hall No. 4, / Booth 12**

Company Name : **BOSKINA IMPEX**
Address : GALA NO. 10/12, ANAND IND. ESTATE, NAVGHAR ROAD, BHAYANDER (E) 401 105.

COUNTRY : INDIA
City : MUMBAI
Contact Person : MR. SAMEER P. SHAH.
Designation : PROPRIETOR
Telephon No. : 022 - 2817 4545/4646.
Fax No. : 022 - 2816 6363
Cell No. : 9820077884
Email : shah_sameer16@yahoo.co.in/e

xports@boskina.in
Website : www.boskina.in
Brand Name : BOSKINA /BOXY
Business Type : MFG. ST. STEEL UTENSILS
Products Details : SPECILISED IN SEE THRU PRODUCTS & DEEP CANISTERS.
Stall No. : **Hall No. 1 / Stall 79**

Company Name : **BUTTERFLY STEEL'S**
Address : Mr. Bharat Bhai Dedhia, Mr. Kishore Mavji Dedhia
City : E/4, Jay Ambe Ind. Estate, Gr. Floor, B. P. Cross Road, No. 5, (E)
Contact Person : BHAYANDER (E) (MHRSTR)-401105
Designation : PROPRIETORS
Telephon No. : 022-39316211, 28046720
Cell No. : 9324590110, 9322214433
Email : butterflyrichlife@gmail.com, butterfly.steel@gmail.com

Website : www.butterflysteel.com
Brand Name : BUTTERFLY
Business Type : MANUFACTURERS
Products Details : STAINLESS STEEL UTENSILS, HOUSEWARE, KITCHENWARE
Stall No. : **Hall No.1 / Booth 85**

Company Name : **CALICO METALS**
Address : 1/B/1 AFRICAWALA ESTATE, OPPCOMMET HOUSE, KEVAL KANTA ROAD RAKHIAL
City : AHMEDABAD
Contact Person : KAPIL GANDHI
Designation : PROPERITOR
Telephon No. : 079-22749236, 22749237
Fax No. : 079-22748995
Cell No. : 090999 11191
Email : calicometal@yahoo.co.in
Website : www.calicometals.net
Business Type : TRADER
Products Details : SS

PIPE/TUBES/COIL/PLATE/SHEET/FITTINGS/FLANGES/
Stall No. : **STALL NO. 70 / BOOTH NO.3**

Company Name : **CAREWELL UTENSIL INDUSTRIES**
Address : PLOT NO. G-715,METODA G.I.D.C.,LODHKA IND. ESTATE RAJKOT
City : RAJKOT
Contact Person : ASHOK BHAI PATEL, DAMJIBHAI PATEL
Designation : C.E.O.
Telephon No. : 2827287726
Fax No. : 2827287726
Cell No. : 9426967152, 9409014785
Email : carewell.industries@yahoo.com
Website : www.casserolecarewell.com
Brand Name : CAREWELL
Business Type : MANUFACTURER
Products Details : ALL STAINLESS STEEL INSULATED CASSEROLE(HOTPOT)

Stall No. : **Stall 50-A / Hall 1**

Company Name : **Chaoan Caitang Shixing Tempered Glass Lid Factory**
Address : No.15 XianEr Industrial Park,Caitang,Chaoan,Chaozhou u,Guangdong,China
City : chaozhou
Contact Person : yaoxuan huang

Designation : SALES MANAGER
Telephon No. : 0768-5632719
Fax No. : 0768-5632210
Cell No. : 13413779999
Email : info@shixingcn.com, shixingcn@hotmail.com
Website : www.shixingcn.com
Brand Name : SHIXINGDA
Products Details : tempered glass lid
Stall No. : **CHINA 33 / Hall 2**

Company Name : **Guangdong Wannuo Machinery Co.,Ltd**
Address : No.6 of Changming West Road,Ronggui Rongli Neighborhood
Committe,Shunde District, Foshan,China (Mainland)

City : Foshan
Contact Person : Qinggui Wan
Telephon No. : 86 13450572818
Fax No. : 86 757 28317106
Cell No. : 86 757 28317106
Email : wanqinggui@fswannuo.com
Website : http://www.fswannuo.com/
Brand Name : WANNUO
Business Type : MANUFACTURERS
Products Details : Polishing machine, grinding machine, welding machine , stainless steel product processing
Stall No. : **CHINA 45 / Hall 2**

Company Name : **GUANGDONG XIANGXINGFA ART GLASS CO.,LTD**

Address : XIANGONG AREA, OUTBOARD OF DONGCAI ROAD, XIANLE'ER VILLAGE, CAITANG TOWN, CHAOAN DISTRICT,CHAOZHOU CITY, GUANGDONG PROVINCE, CHINA

City : CHAOZHOU
Contact Person : WANG SHIXIONG
Designation : SALES MAN
Telephon No. : 0768-5634972
Fax No. : 0768-5634970
Cell No. : 13827339012
Email : sales01@xxfglass.com
Website : xxfglass.en.alibaba.com
Brand Name : XIANGXINGFA (XXF)
Business Type : MANUFACTURERS
Products Details : Largest manufacturer for glass lid in China, producing all kinds of tempered glass lids, with the capacity up to 6 million pcs/month.
Stall No. : **CHINA 46 / Hall 2**

Company Name : **CLASSIC IMPORTS PVT. LTD.**
Address : 1001, Corporate Evenue, Near Udyog Bhava, Sanawala Crossland, Goregaon (E)
City : MUMBAI-400101
Contact Person : Amit J. Patel
Telephon No. : 022-32522726, 64519771
Cell No. : 9323647537, 9892415046, 8454047409

Email : classicimportspvtltd@yahoo.co.in, gdk2805@yahoo.co.in, amitjpatel69@gmail.com
Business Type : IMPORTER
Products Details : KITCHEN APPLIANCES, HOUSEWARE PRODUCTS
Stall No. : **HALL NO. 4, / BOOTH NO. 7**

Company Name : **D.B ENGINEERING**
Address : A-119, Okhla Industrial Area, Phase-II, New Delhi
City : Delhi
Contact Person : Shri Raman Raina
Designation : G.m Admin

Cell No. : 9910395553
 Email : sales@atlasnives.com
 Website : www.atlasnice.com
 Brand Name : Atlas K Nice
 Business Type : Manufacture
 Products Details : Cutting Blaid, Knif, All Kichenwere.

Stall No. : **Hall No. 2 / Stall 57, 58**

Company Name : **D. R. MACHINE TOOLS**
 Address : 306, SUR SARTHI COMPLEX, OPP. CENTRAL BANK, AMBAWADI,
 City : AHMEDABAD-380 006. GUJARAT,INDIA.
 Contact Person : RAKESH SHAH / BALKRISHNA SHAQH
 Designation : PROPRIETOR / HEAD MARKETING
 Telephone No. : +91 - 79 - 26407965
 Fax No. : -----N. A.-----
 Cell No. : +91 - 98250 95638 / +91 - 98981 22147
 Email : info@drmachinetool.com
 Website : www.drmachinetool.com
 Brand Name : TECHNO
 Business Type : MANUFACTURING
 Products Details : CENTRELESS TUBE /ROD POLISHING MACHINE, SURFACE POLISHING MACHINE, PIPE NOTCHING MACHINE

Stall No. : **Hall No. 2 / Stall 18**

Company Name : **DeeTee Industries Ltd.**
 Address : 28/33, Pologround Industrial Estate,
 City : Indore - 452 015
 Contact Person : Mr. Rajesh Dubey
 Designation : Sr. Manager (Mktg)
 Telephone No. : 0731-4296711/ 4296777
 Fax No. : 0731-4296766
 Cell No. : 9826434575
 Email : rajeshdubey@deeteegroup.com
 Website : www.deeteegroup.com
 Brand Name : DeeTee
 Business Type : MANUFACTURERS
 Products Details : Slitting Cutter, Spacer, Rubber Spacer, OASD, Work Rolls, Leveler rolls,

Stall No. : **Hall No. 2, / Booth 21**

Company Name : **DEV ABRASIVE**
 Address : 79 SHIV GANGA INDL ESTATE, LKESHWARI, BHAGWANPUR
 City : ROORKEE; UTTRAKHAND
 Contact Person : NITESH KEDIA / RAJENDRA KEDIA
 Designation : SALES TECHNICAL
 Telephone No. : 022-28828419 , 28812186 , 28804825
 Cell No. : 98334 45444
 Email : info@devabrasive.in
 Website : www.devabrasive.in
 Brand Name : Hermes Abrasives
 Business Type : MANUFACTURER
 Products Details : ABRASIVES

Company Name : **DEV ENTERPRISE**
 Address : 26/2 , Makani Ind. Estate Bhaji Mkt. Road , B,P Road Bhayender (E)
 City : Thane
 Contact Person : Ganesh . Manjrakar
 Designation : Owner
 Telephone No. : 022-39317444
 Cell No. : 9323751008 , 7738682661
 Email : Sale@dev-entp.com
 Website : www.dev-entp.com
 Business Type : Manufacture
 Products Details : Hotelwere , Barwere , Tablewere , All Kitchenwere. Items

Stall No. : **Hall No. 1 / Stall 26**

Company Name : **DEVJAS INTERNATIONAL**
 Address : 906, K.L.J. Tower North, Netaji Subhash Place, Pritampura
 City : DELHI-110034
 Designation : PROPRIETORS
 Telephone No. : 011-32502451, 27475899, 27475646
 Cell No. : 9312222851, 9350041466,
 Email : shankeshwarjain@gmail.com, devjastading@gmail.com,
 Website : www.devjasinternational.com
 Brand Name : DEVJAS
 Business Type : MANUFACTURERS & EXPORTER, TRADING
 Products Details : S. S. pata,sheet and coils and raw material, fflat, round,
 Stall No. : **Hall No. 4, / Booth 27**

Company Name : **DHARNIDHAR METAL INDUSTRIES**
 Address : SHOP NO 4 R.K ESTATE BEHIND VIJAY INDUSTRIAL ESTATE, NEAR BHIKSHUK GRUH, ODHAV,
 City : AHMEDABAD
 Contact Person : PRADEEP JAIN
 Designation : Director
 Telephone No. : 079-22977027
 Cell No. : 9825517968, 9426014791
 Email : jainpradeep01@gmail.com,dharnidharmetal@gmail.com
 Website : www.thekitchenkraft.com
 Brand Name : Kalash, Kitchen kraft
 Business Type : MANUFACTURE
 Products Details : HOUSEHOLD, Cookware, CopperwareKitchenwer, containers, Plates

Stall No. : **Hall No. 1, / Booth 33**

Company Name : **DIPLOMA METAL INDUSTRIES**
 Address : B/7, RAVI ESTATE, AMBIKA NAGAR, NEAR HANUMAN TEMPLE, ODHAV
 City : AHMEDABAD
 Contact Person : BABULAL K. BOTHARA, Ramesh D. Bothara
 Designation : Propirter
 Telephone No. : 079-22972686
 Cell No. : 9426170801
 Email : bkbothara9@gmail.com, nareshshah1954@gmail.com
 Brand Name : DIPLOMA
 Business Type : MFRS
 Products Details : HOUSEHOLD, Thali, pwali, Plate

Stall No. : **Hall No. 1, / Booth 70**

Company Name : **DIVYANG METALS (TITU)**
 Address : B-26, Near Raja Park, Wazirpur Indl Area
 City : NEW DELHI-110052
 Contact Person : Mr. Mahesh Gogia, Mr. Arun Gogia
 Designation : PARTNER
 Telephone No. : 011-27375296, 42473296
 Cell No. : 9871147755, 9560188885
 Email : divyangmetals@yahoo.co.in
 Brand Name : DIVYANG
 Business Type : MANUFACTURERS & TRADERS
 Products Details : Stainless Steel Utensils
 Stall No. : **HALL NO. 4, / BOOTH NO. 27**

Company Name : **ELECTROTHERM (INDIA) LTD.**
 Address : Survey no .72, Palodia, Via Thaltej
 City : AHMEDABAD-382115
 Contact Person : Mr. Shailesh Bhandari, Mr.Mukesh Bhandari
 Designation : PROPRIETORS

Telephone No. : 02717-660632, 650550, 233072
 Cell No. : 9825159296
 Email : mkt@electrotherm.com, ho@electrotherm.com
 Website : www.electrotherm.com
 Brand Name : ELECTROTHERM
 Business Type : MANUFACTURERS
 Products Details : Steel & Pipe, Steel Division
 Stall No. : **Hall No. 2, / Booth 23**

Company Name : **Energy Mission Machinerics (India) Private Limited**
 Address : Plot No. 5210, Phase - Iv, Opp. Ramol Police Chowky, G.I.D.C. Vatva, Ahmedabad - 382445, Gujarat, India
 City : Ahmedabad
 Contact Person : Mr. Dinesh Chaudhary / Mr. Snehal Mehta
 Designation : Director
 Telephone No. : 079-25840067 / 40085558
 Fax No. : 079-4008 5558
 Cell No. : 098243 03302 / 098244 81470
 Email : info@energymission.com ; energymission@gmail.com
 Website : www.energymission.com
 Brand Name : ENERGY MISSION
 Business Type : MANUFACTURERS
 Products Details : Hydraulic & NC Shearing Machines | Hydraulic Press Brake | NC & CNC Press Brakes | Hydraulic Iron worker | Plate Bending Machines | Hydraulic Press | C-Frame Press | Horizontal Press | Busbar unit & special purpose machine

Stall No. : **Stall no: 64 A (Hall: 2)**

Company Name : **EVERSHINING INTERNATIONAL (H.K.) LTD.**
 Address : G.Z OFFICE: ROOM 1907-1908, HUANGCHAO GE, NANTIAN BUILDING, ZHUJIANG NEW CITY, GUANGZHOU
 City : GUANGZHOU
 Contact Person : Mr.Alan Zheng
 Designation : Marketing Manager
 Telephone No. : 0086-20-38250201 / 38207049
 Fax No. : 0086-20-38207425
 Cell No. : 0086-18576400828
 Email : jack_ys@163.com; alanzheng2011@sina.com
 Website : www.eversun.com; www.gz-eversunny.com
 Business Type : MANUFACTURER/AGENCY
 Products Details : Stainless Steel Press Pipe Fitting, Metal Processing Machinery

Stall No. : **Hall No. 2, / Booth 16**

Company Name : **FABRIMECH ENGINEERS PVT LTD**
 Address : 32 SIDCO INDUSTRIAL ESTATE, AMBATTUE ESTATE.
 City : CHENNAI
 Contact Person : THOMAS K VARGHESE / STEPHEN K THOMAS
 Designation : DIRECTORS
 Telephone No. : 9840136997 / 9840049486
 Fax No. : 91-44-26252039
 Cell No. : 9840136997 / 9840049486
 Email : Fme@fabrimech.com
 Website : Www.fabrimech.com
 Brand Name : FABRIMECH
 Business Type : MANUFACTURE EXPORTER
 Products Details : STAINLESS STEEL WESTERN CLOSET, SS SQUATTING PANS AND TOILETS

Stall No. : **HALL 2 / Stall 74**

Company Name : **FEIDA (Anhui) Advanced Material Teconology Co., Ltd.**
 Address : Xingang road No.9, Gangkou Industry park, Ningguo City, Anhui Province, China
 City : Ningguo, Anhui, China
 Contact Person : James Wu , Grand Xie
 Designation : Export Manager
 Telephone No. : 0086-563-4871668
 Fax No. : 0086-563-4871866 ext. 888
 Cell No. : 0086-18010813743
 Email : james.wu@feida-group.com
 Website : www.ahfdgy.com www.feida-group.com
 Brand Name : FEIDA
 Business Type : MANUFACTURERS
 Products Details : cold rolled coils of stainless steel
 Stall No. : **HALL 2 / China - 34**

Company Name : **FILCO TRADE CENTRE PVT. LTD.**
 Address : 11, Purneshwar Chambers, 1st Floor, Opp. Dinesh Hall, Nr. Income Tax
 City : AHMEDABAD-380009
 Contact Person : Mr. Deepak M. Shah, Mr. Hitesh N. Shah
 Designation : Owner
 Telephone No. : 079 27545747, 079 27545748
 Fax No. : 079 27541949
 Email : info@filcobearing.com, filco11@gmail.com, bhavya@filcobearing.com
 Website : www.filcobearing.com
 Brand Name : FILCO
 Business Type : TIMKEN, FYH, IKO, NACHI, TWB
 Products Details : BEARINGS
 Stall No. : **HALL NO.2 / BOOTH NO. 41**

Company Name : **FINISHING TECHNOLOGIES (FINTECH)**
 Address : C-206, RNS Shanti Nivas, Next to RNS Motors Tumkur Road, Yashwantpur
 City : BANGLORE-560022 (KARNATAKA)
 Contact Person : Ravindra Salunke
 Designation : Owner
 Telephone No. : 080-23743222
 Cell No. : 9663331848
 Email : sales.fintech@gmail.com, ravindra@fintech.info
 Website : www.fintech.info
 Brand Name : FINTECH
 Business Type : MANUFACTURERS
 Products Details : Automation And Coating Lines For Cookware Ind. Surface Finishing, Laser Systems,
 Stall No. : **Hall No. 2 / Stall No. 85**

Company Name : **Foshan Baiguan Science and Technology Co.,Ltd.**
 Address : Baiguan Building, Shishan Twon, Nanhai District, Foshan City, Guangdong Province, China.
 City : Foshan City
 Contact Person : Eric Xiao
 Designation : Director
 Telephone No. : 0086-757-88389896
 Fax No. : 0086-757-88389878
 Cell No. : 0086-139 2992 2994
 Email : sales@tubesmill.com
 Website : www.tubesmill.com
 Brand Name : Baigon
 Business Type : MANUFACTURERS
 Products Details : Tube mill/Roll set/ERW pipe making machine/Polishing machine/Embossing machine/Inside weld bead remove/ Annealing machine
 Stall No. : **CHINA-35**

Company Name : **Foshan Kun Liu Sheng Composite Material Co.,Ltd**
 Address : No.27-33,2/F,Block5,(International)Metal Center Lanshi,Chancheng District,Foshan City,Guangdong Province,528000,CHINA
 City : Foshan ,Guangdong
 Contact Person : Rick Lee
 Designation : Foreign Trade Sales Manager
 Telephone No. : +86-757-83836678
 Fax No. : +86-757-83836678
 Cell No. : +86-13380233923
 Email : sales@klsh.com
 Website : www.klsh.com
 Brand Name : KUN LIU SHENG
 Business Type :

MANUFACTURERS/EXPORTER /MPOTER/TRADER
 Products Details : Metal composite material,metal clad plate,stainless steel clad plate,cookware circle,stainless steel plate/coil/pipe etc
 Stall No. : **CHINA 31**

Company Name : **FOURTUNE METCAST**
 Address : 102, PARMATMA PLAZA, HOSPITAL ROAD, CHETAK CIRCLE, UDAIPUR,
 City : Udaipur
 Contact Person : ASAD SIDDIQUI
 Designation : Owner
 Cell No. : 9414167452
 Email : fourtune.metcast@yahoo.com
 Brand Name : FNC
 Business Type : Manufacture
 Products Details : Ralling , baloster, Sheet

Company Name : **GALAXY KITCHEN APPLIANCES**
 Address : "OM" 13-BALAJI IND ESTATE, NEAR MURLIDHAR WEIGH BRIDGE, MANDA DUNGAR MAIN ROAD, NEAR AJI DAM CHOKDI,
 City : RAJKOT 360003 (GUJARAT) INDIA
 Contact Person : Nilesh Raiyani, Rohit Raiyani
 Designation : Owner
 Cell No. : 9825620772 / 9925220772
 Email : INFO@LITEXINDIA.COM
 Website : WWW.LITEXINDIA.COM
 Brand Name : LITEX COOKWARE
 Business Type : MANUFACTURERS
 Products Details : MANUFACTURER AND EXPORTER OF ALUMINIUM PRESSURE COOKER AND OTHER COOKWARE ITEM
 Stall No. : **Stall 73 / Hall 1**

Company Name : **GANPATI INDUSTRIES PVT. LTD.**
 Address : 54,Vikas Estate nr.Anil Starch Mill,Bapunagr
 City : AHMEDABAD
 Contact Person : Ratan Jain, Ankit Jain, Jagdish Jain
 Designation : Partner
 Telephone No. : 079-22922992
 Cell No. : 9426011536, 8866144731
 Email : i10doorfitting@gmail.com,info@i10doorfitting.com
 Website : http://www.i10doorfitting.com/
 Brand Name : i10
 Business Type : MANUFACTURERS
 Products Details : MANUFACTURING MORE THAN 200 ITEMS SUCH AS ALDROPHANDLE,TADI,TOWER BOLT,DOOR STOPPER,GATE-HOOK,HINGES,SCREW,ZULLA, TABLE CHAIN ETC.

Stall No. : **Hall No. 2 / Booth No. 79**

Company Name : **GARUDA OVERSEAS**
 Address : 13, Mangal Murti, Opp. City Gold, Ashram Road
 City : AHMEDABAD
 Contact Person : Mr. Ugamraj Hundia, Mr. Jitender Hundiya
 Designation : Owner
 Telephone No. : 079-26574869 (O),
 Fax No. : Fax 079-26574870
 Cell No. : 9998111777
 Email : info@garudaoverseas.com, garuda@garuda.co.in, www.garuda.co.in
 Website : www.garuda.co.in
 Brand Name : GARUDA
 Business Type : Manufacture & Exporter
 Products Details : M.S. angel, channerl & bar, St. steel & Aluminium, Sheet, plate, pipe, Rod, flat, circle, coil, wire, HC, HCR, copper, brass,

Stall No. : **Hall No. 4 / Booth No.1**

Company Name : **Gaurav Metal Industries**
 Address : Gaurav Metal Industries, Behind Ishar Sar Gurdwara, Bye Pass,Village Panj Dhera, PHILLLAUR,Dist-Jalandhar, Punjab, INDIA,
 City : Phillaur
 Contact Person : Gorav Gupta
 Designation : Owner
 Telephone No. : 8283811651
 Cell No. : 9814048651, 9855048651
 Email : gauravmetalindustries@yahoo.com; info@ironutensils.com
 Website : www.ironutensils.com
 Brand Name : LUCKY
 Business Type : MANUFACTURERS/EXPORTER
 Products Details : Iron Cookwares (Iron Tawa, Iron Kadai, Iron Frypan, Iron Dosa Tawa), Pressure Juice Machine, Saag/Palak Cutter, Puri Press, Wooden Items

Stall No. : **Hall No. 1 / Booth No.34**

Company Name : **GLARE APPLIANCES PVT LTD**
 Address : Plot No. 188-C, Rajkot Gundal Road, National Highway No. 27, VERVAL (SHAPER), Dist.:
 City : RAJKOT (GUJ)-360024
 Contact Person : Mr. Jayanti Bhai B. Patel
 Position / Designation : Owner
 Telephone No. : 0281-252391, 252512
 Cell No. : 98240 66323
 Email : sales@glareindia.com
 Website : www.glareindia.com
 Brand Name : GLARE APPLIANCES
 Business Type : MANUFACTURERS & EXPORTER

Products Details : S S Utensils; Specialist in China Plate & Chibba
 Stall No. : **HALL NO. 1 / BOOTH NO. 89**

Company Name : **GLARE HOME PRODUCTS PVT. LTD.**
 Address : PLOT NO. 16, SURVEY NO. 172/1/P, OPP. KRISHNA PARK HOTEL, NR. RAILWAY CROSSING, SILVER INDL. EST., 8-B N/H, KOTHARIYA
 City : RAJKOT
 Contact Person : DHARMESH BHAI
 Designation : MARKETIN MANAGER
 Cell No. : 9898100121, 9377112100
 Email : info@blazeindia.in
 Website : www.blazeindia.in
 Brand Name : BLAZE
 Business Type : MFRS
 Products Details : KITCHEN TOOLS & CUTLERY
 Stall No. : **Stall 71 / Booth 1**

Company Name : **Globe Steel (Global Houseware Pvt. Ltd.)**
 Address : 153E, EPIP, HSIDC, Kundli, Sonapat, Haryana - 131028
 City : Haryana
 Contact Person : Mr. Naresh Basia
 Designation : Director
 Telephone No. : 01302219567 - 70
 Fax No. : na
 Cell No. : 8222811893
 Email : naresh@globesteel.com
 Website : www.globesteel.in
 Brand Name : Globe Steel, Steel 'n' Décor
 Business Type : Manufacturers and Exporters of Stainless Steel and Aluminum Cookware
 Products Details : Stainless Steel Houseware, Kitchenware and Aluminum Cookware
 Stall No. : **Hall No.1, Booth No. 20**

Company Name : **G.M. INDUSTRIES**
 Address : 10, Samarat Industrial, B/H St. Workshop, Near Satyanarayan Weigh Bridge, Gondal Road, GUJARAT
 City : RAJKOT (GUJ) -360002
 Contact Person : Sarit M. Kansagra
 Designation : PROPRIETORS
 Telephone No. : 0281-2368982
 Cell No. : 9898151113
 Email : ganeshmetalind@yahoo.in
 Business Type : MANUFACTURERS
 Products Details : HOUSEWARE, KITCHENWARE
 Stall No. : **Hall No. 1, / Booth 32**

Company Name : **Gokul International**
 Address : Gala No.2, Roopal Industrial Estate, H.P. Gas Godown Galli, Bhyandar (E), Thane -401 105
 City : Maharashtra Mumbai
 Contact Person : Manoj Jain and Vipin Jain M
 Designation : Proprietor/ Owner
 Telephone No. : 022-39315499
 Fax No. : 022-2804-5850
 Cell No. : 9322122218/9769517888
 Email : gokulinternational1@gmail.com
 Website : www.rgokulinternational.com (it ll take more 10 days to start)
 Brand Name : Gokul International
 Business Type : Manufacture
 Products Details : Stainless Steel Fancy Utensils
 Stall No. : **Hall No. 1, / Booth 81**

Company Name : **GRINDMASTER MACHINES PVT. LTD**
 Address : B-10, B-14, MIDC, NEAR RAILWAY STATION, AURANGABAD-431005(M.S.)
 City : AURANGABAD-431005(M.S.)
 Contact Person : MRS. M.M.KELKAR
 Designation : MANAGING DIRECTOR
 Telephone No. : 0240-2374102,2374106, 2374106
 Fax No. : 0240-2376205
 Cell No. : 9822091808, 9049998311
 Email : sales@grindmaster.co.in
 Website : www.grindmaster.co.in
 Brand Name : GRINDMASTER
 Business Type : MANUFACTURING
 Products Details : POLISHING,BELT GRINDING,BUFFING,MICROFINISHING,DEBURRING MACHINES
 Stall No. : **HALL 2, STALL 50**

Company Name : **GRINDTOOLS**
 Address : E-11, BHOSARI INDUSTRIAL ESTATE PUNE- 44 026 MH.
 City : PUNE
 Contact Person : MR. YATIN MEHER
 Designation : PARTNER
 Telephone No. : 020 27120091 / 92
 Fax No. : -

Cell No. : 9822093811
 Email : info@grindtools.com
 Website : www.grindtools.com
 Brand Name : GRINDTOOLS
 Business Type : MANUFACTURERS
 Products Details : GRINDING , POLISHING & BUFFING MACHINE
 Stall No. : **Stall 42 (Hall - 2)**

Company Name : **Grandvic (Guangzhou) Co.,Ltd**
 Address : Unit A2-301,Balifang Creation Zone,Hezheng Street Lianhe Area, Baiyun District,Guangzhou,China PRC
 City : guangzhou
 Contact Person : DODGE LEUNG
 Designation : General Manager
 Telephone No. : 0086-20-37413786
 Telephone No. : 0086-20-36772084
 Cell No. : 0086-13570089639
 Email : galaport@163.com
 Brand Name : Grandvic
 Business Type : MANUFACTURERS/EXPORTER /IMPOTER/TRADER

Products Details : Marterials for cookware
 Stall No. : **CHINA 30**

Company Name : **GUANGDONG METAL FORMING MACHINE WORKS CO., LTD.**
 Address : NO.1 JINDOU ROAD, NANGUOXI ROAD, DALIANG, SHUNDE, FOSHAN, GUANGDONG, CHINA
 City : FOSHAN CITY, GUANGDONG PROVINCE
 Contact Person : SYMON CHOW
 Designation : OVERSEAS SALES MANAGER
 Telephone No. : 0086-757-25638932
 Fax No. : 0086-757-22637508
 Cell No. : 0086-13927288266
 Email : zhough@guangduan.cn
 Website : www.guangduan.cn
 Brand Name : GUANGDUAN
 Business Type : MANUFACTURERS
 Products Details : MECHANICAL PRESS, HYDRAULIC PRESS, AUTOMATIC PRODUCTION LINE
 Stall No. : **CHINA 32**

Company Name : **GULZARMAL AND SONS**
 Address : GOAL HATTI CHOWK ,KATRA
 City : KANHAYA
 Contact Person : AMRITSAR
 Designation : KULDEEP
 Designation : OWNER
 Telephone No. : 0183-2531685
 Cell No. : 9216450685
 Email : gulzarmalandsons@gmail.com
 Brand Name : BHANU PRIYA
 Business Type : S.S UTENCILS
 Products Details : STAINLESS STEEL UTENCILS, ALUMINIUM UTENCILS, PRESSURE COOKERS
 Stall No. : **Hall 1 / Stall 90**

Company Name : **GURUDEVA ENGINEERING WORKS**
 Address : GALA NO. 1, JAYSHREE MISTRY COMPOUND, NR. GAMDEVI TEMPLE, GAMDEVI ROAD, BHANDUP(W)
 City : MUMBAI-400028
 Contact Person : K. V. BHASI
 Position / Designation : PROPRIETORS
 Telephone No. : 22-23823723
 Cell No. : 9829374498
 Email : gurudevaenggworks@gmail.com
 Business Type : MANUFACTURERS

Products Details : MACHINERY
 Stall No. : **Hall No. 2, / Booth 7**

Company Name : **H.K. INTERNATIONAL**
 Address : 42, PARAMASIVA STREET, PARK TOWN,
 City : CHENNAI
 Contact Person : NARENDER JAIN
 Designation : CEO
 Telephone No. : 044-23465411, 43233276
 Cell No. : 9840144344
 Email : globusware@gmail.com
 Website : www.globusware.in
 Brand Name : GLOBUS
 Business Type : MFRS
 Products Details : KITCHEN NOVELTIES
 Stall No. : **STALL NO. 1 / HALL 1**

Company Name : **HAMRIYAH FREE ZONE AUTHORITY**
 Address : P.O.Box: 1377,
 City : SAHARJAH-(UAE)
 Contact Person : MUHAMED BASHEER
 Designation : (+971) 71505293745
 Telephone No. : (+971) 6 5263333
 Fax No. : (+971) 6 5263555
 Email : sales@hfza.ae, info@hfza.ae
 Website : http://www.hfza.ae/
 Brand Name : HAMRIYAH FREE ZONE
 Business Type : MEDIA
 Products Details : BUSINESS DIRECTORY
 Stall No. : **Hall No. 2, / Booth 53**

Company Name : **HERO STEEL INDUSTRIES**
 Address : MANDI ROAD
 City : JALANDHAR CITY
 Contact Person : KANAV GUPTA
 Designation : MG. PARTNER
 Telephone No. : 0181-2224542
 Fax No. : 0181-2224542
 Cell No. : 9888145154
 Email : hero_steel@hotmail.com
 Website : hsfittings.com
 Brand Name : H.S.I
 Business Type : MANUFACTURER
 Products Details : S.S INVESTMENT CASTINGS, PIPE FITTINGS, VALVES, DAIRY FITTINGS, DAIRY VALVES,
 Stall No. : **HALL NO. 2 STALL NO. 82**

Company Name : **HIMA ENGINEERING WORKS**
 Address : 15, Shanti Estate ,Ramol Road , CTM ,
 City : Ahmedabad-26(Gujarat)
 Contact Person : Rajesh Patel
 Cell No. : 75677 70005 , 75677 70003
 Email : rajeshhpatel74@gmail.com
 Website : www.himaengineering.com
 Business Type : MANUFACTURERS
 Products Details : S. S. Tube Mill Machines, S. S. Polishing Machines, S. S. Tube Straightening Machines, Turk Head Assembly Rolls for Tube Mill All Type of tube processing equipments,
 Stall No. : **HALL NO.2 / BOOTH NO. 24**

Company Name : **HONEST ENTERPRISE LIMITED**
 Address : 118 MEGHDOOT APARTMENT, NEAR APSARA CINEMA, PRATAPNAGAR ROAD,
 City : VADODARA
 Contact Person : MR. HITESH VAGHELA
 Designation : DIRECTOR
 Telephone No. : 0265-2424057/ 0265-2434057
 Fax No. : 0265-2422960
 Cell No. : 0091-9376218378
 Email : honest@honestlimited.com
 Website : www.honestlimited.net
 Brand Name : HONEST
 Business Type : EXPORTER/IMPOTER/TRADER /BUYING AGENT



Products Details : STAINLESS STEEL
CHEETS/COILS/PLATES/PIPES/
CIRCLES IN ALL GRADES
Stall No. : **STALL NO. 51/ HALL NO. 3**

Company Name : **IDEA FACTORY
EQUIPMENTS PVT LTD**
Address : PP-46, ANAND PARBAT
INDUSTRIAL AREA, STREET
NO. 10,
City : DELHI-110005
Contact Person : AJAY WADHWA
Designation : PROPRIETORS
Telephone No. : 011-28761442
Fax No. : 011-
27785762/64534777/28761442
Cell No. : 9810052956
Email : sales@ideafactory.co.in
Website : www.ideafactory.co.in
Business Type : MANUFACTURERS
Products Details : Metal cutting machine, multi jet
etching machine, chemical
etching machine, etching
machine, baking oven,
rapidetcher, name plate etching
machine
Stall No. : **Hall No. 2, / Booth 1**

Company Name : **INNOVATIVE TECHNOLOGY**
Address : 26, MAHADEV ESTATE-III, B/H
RAMOL POLICE
STATION, RAMOL ROAD, C.T.M.,
AMRAIWADI,
City : AHMEDABAD
Contact Person : ARVIND B PATEL
Designation : owner
Cell No. : 9825398702
Email : info@innovativetechnologies.co.in,
arvindmotka@rediffmail.com
Website : www.innovativetechnologies.co.in
Business Type : Mrs
Products Details : BUFFING MACHINERY
Stall No. : **STALL 61 / HALL 2**

Company Name : **Inductotherm (India) Pvt. Ltd.**
Address : Bopal, Ahmedabad 380058
City : Ahmedabad
Contact Person : Rajkumar VM.
Designation : Marketing Executive
Telephone No. : 02717 231961
Fax No. : 02717 231266
Cell No. : 9374578586
Email : rajkumar@inductothermindia.com
Website : www.inductothermindia.com
Brand Name : INDUCTOTHERM GROUP
INDIA
Business Type : Manufacturers
Products Details : melting/heating/welding/vacuum
equipments/long products.
Stall No. : **Hall No.2, Stall No.52**

Company Name : **Innovative Clad Solution Pvt Ltd**
Address : Plot No M-7, Phase II, Misc
Zone,
Special Economic Zone,
Pithampur,
District Dhar, 454774,
Madhya Pradesh,
India
City : Pithampur (near Indore)
Contact Person : Piyush Vijayvergia
Designation : Head - Sales and Marketing
Telephone No. : 7292402807
Fax No. : 7292402800
Cell No. : 7345881131
Email :

Website : pvijayvergia@innovativecladsolutions.com
www.innovativecladsolutions.com

Brand Name : Innoply®
Business Type : Manufacturer
Products Details : Clad Metal (5 ply, 3 ply, 2 ply)
coils. Application: 5 Ply
Innoply® for Energy efficient
cookware to be used on
induction as well as gas ; 2 ply
Tableware and cookware of
Copper+Stainless Steel; 2 Ply
Cookware of Stainless Steel
+ Aluminum.
Stall No. : **Stand No 6 - Hall No 4**

Company Name : **ISC UDYOG**
Address : ISC Compound, Janata Market,
L.B.S. Marg, Bhandup (W),
City : MUMBAI-400078
Contact Person : Ms. Kamna Pandey
Telephone No. : 022 6580 3945
Fax No. : 022 2504 0553
Email : info@iscudyog.com /
iscudyog@gmail.com
Website : www.iscudyog.com
Brand Name : ISC
Business Type : MANUFACTURERS & TRADING
Products Details : Electro / Permanent Magnets,
Magnetic Separators, Hoppers,
Vibro Feeders., E.O.T Electric
Hoist, Goliath, Jib, Gantry
Cranes., Hydraulic Grabs &
Hydraulic Bailing Press,
Continuous Billet Casting
Machines, LRF & Electric Arch
Furnaces
Stall No. : **Hall No. 2 / Booth No. 53-A**

Company Name : **INDIAN STAINLESS STEEL DEVELOPMENT ASSOCIATION**
Address : L-22/4, DLF Phase-II,
City : GURGAON -122002
Contact Person : N.C. Mathur
Position / Designation : Persident
Telephone No. : 0124- 4375501, 02, 03, 509
Cell No. : 9810026992, 9810404044,
9910007552
Email : nissda@gmail.com
Website : http://stainlessindia.org/
Company Name : **STEEL MARKET INFO**
Address : 2nd Floor, Nirmal Tower,
Chopasni Road,
City : Jodhpur
Contact Person : R. L. Chouadhary
Position / Designation : Organizer
/ Editor-in-Chief
Telephone No. : 091-291-2441415, 2632533
Fax No. : 2632533
Cell No. : 773-773-1015 / 9314713809
Email : info@steelmarketinfo.com
Website : www.steelmarketinfo.com /
www.inoxhousewareshow.com /
steeldeal.in
Brand Name : STEEL MARKET INFO
Business Type : PUBLISHER / ORGAZINER
Products Details : Service to Trade Since 1999

Company Name : **J. J. THEROMWARE PVT LTD (ARIHANT METAL WORKS)**
Address : PLOT NO. J/74, M.I.D.C.
TARAPUR, BOISAR(W)
City : THANE
Contact Person : HARDIK J. GALA, NAVIN
H.GALA
Designation : Director
Telephone No. : 022-33937939
Cell No. : 9320248811, 9820148811,
9820320691
Email : omex03@yahoo.com

Website : www.omexind.com
Brand Name : OMEX
Business Type : mfrs & export
Products Details : SS HOTPOT& CASSEROLE
Stall No. : **STALL 66 / HALL 1**

Company Name : **JAGDAMBA EXPORTS**
Address : Plot No. 153 D, I & J, HSIIDC
Industrial Area, Epip Kundli
SONEPAT (HARIYANA)-131028
City :
Contact Person : Mr. Pawan Kansal
Designation : OWNER
Telephone No. : 0130-2374453-56
Cell No. : 9811178827, 9810298827
Email : info@jagdambafatware.com,
pawan@jagdambafatware.com,
india@jagdambafatware.com
Website : www.jagdambafatware.com
Brand Name : SHRI & SAM, JAGDAMBA
Business Type : MANUFACTURERS &
EXPORTER
Products Details : S.S CUTLERY
Stall No. : **HALL NO. 1, / BOOTH NO. 17**

Company Name : **JAGGO OVERSEAS**
Address : B-35/3 A, GT Karnal road,
Industrial Area
(Behind Shakti Nagar
Telephone Exchange)
City : DELHI-110033
Contact Person : ARUN TAYAL
Designation : Owner
Telephone No. : 011- 27129671 / 2
Fax No. : 011- 27129673
Cell No. : 9871121080
Email : gautamtayal@yahoo.co.in,
reports@trademart.in
Website : www.jaggooverseas.com
Business Type : MANUFACTURERS &
TRADERS
Products Details : Electroplating Chemical, Rice
Machines, Polishing
Compound, Abrasive
Stall No. : **HALL NO. 3 / BOOTH NO. 55**

Company Name : **Jass Metalkraft Pvt. Ltd.**
Address : G-72 Sarvodaya Nagar, 1st
Panjrapole Lane, C.P Tank
Mumbai 400004
City :
Contact Person : Amar Shah
Designation : Director
Telephone No. : +91-22-22424137
Fax No. : +91-22-30084137
Cell No. : +91-98332 75339
Email : help@chefkraft.in
Website : www.chefkraft.in
Brand Name : Chefkraft
Business Type : Manufacturers/Exporter/Importe
r
Products Details : Tri Ply Body Cookware,
Storageware manufacturer
Stall No. : **Hall 1 - Booth 72**

Company Name : **Jattin Enterprises**
Address : Kh no. 620,new friends colony,
kundali, sonipat Haryana
131028
City : Sonipat
Contact Person : Ram
Designation : Marketing
Telephone No. : 9990854980
Fax No. : NA
Cell No. : 9582888989
Email : ram@jattinenterprises.com
Website : www.jattinenterprises.com
Brand Name : Jattin Enterprises (JE)
Business Type : Manufacturer/Trader
Products Details : Steel kitchenware & household
products
Stall No. : **Hall no : 4, Booth No. : 21**

Company Name : **JAY GURUDEVA METAL**

Address : 13/14 Aaradhan Industrial Estate, Navgrah Road, Nr Union Bank, Bhayander E
 City : MUMBAI
 Contact Person : Dinesh Khinvesra
 Designation : Propirter
 Telephone No. : 022-39317890, 32993890
 Cell No. : 9324404692
 Email : dinesh.videocon73@gmail.com
 Website : www.jaygurudevmetal.com
 Brand Name : Tuff Line
 Business Type : mfrs
 Products Details : SS Fancy Bowl, Plate
 Stall No. : **STALL 96 / HALL 1**

Company Name : **Jay Kay Enterprises**
 Address : A-127 Wazirpur Industrial Area
 City : Delhi
 Contact Person : Akshay Bansal
 Designation : Director
 Telephone No. : 1127376423
 Cell No. : 9910076027
 Email : jaykayent@sify.com
 Website : www.jaykayenterprises.co.in, www.mavenstainless.com
 Brand Name : Maven Stainless, AB Inox
 Business Type : Manufacturing
 Products Details : Stainless steel sheets, coil, pipes, blanks, cutlery & utensils
 Stall No. : **STALL 20 / HALL 3**

Company Name : **JAY MA KHODIYAR ENGINEERS**
 Address : 2/8, SORATHIYAWADI,
 City : RAJKOT
 Contact Person : NITIN BHAI, VIJAY BHAI
 Designation : Propirter
 Cell No. : 9825076472, 9374124272
 Email : jaymaakhodiyar@yahoo.com
 Website : WWW.perferctkitchenware.com
 Brand Name : PERFECT
 Business Type : MFRS
 Products Details : ALL KITCHENWARE
 Stall No. : **STALL NO. 7 / HALL 1**

Company Name : **JAY-SHREE MACHINES PVT. LTD. (KISHAN)**
 Address : PLOT NO. G-1148, ROAD NO. G-1, G.I.D.C. METHODA
 City : RAJKOT
 Contact Person : RAJENDRA HARSORA
 Designation : MD
 Telephone No. : 02827-287835, -36
 Cell No. : 9427221046
 Email : jayshreemachines@ymail.com
 Website : www.jayshreemachines.com
 Brand Name : KISHAN
 Business Type : MFRS
 Products Details : MACHINERY
 Stall No. : **STALL 63 / Hall 2**

Company Name : **Jieyang Guangta Industrial Co.,Ltd**
 Address : New Industrial Area , Baita Town , Lancheng District , Jieyang city, Guangdong province , China
 City : Jieyang city
 Contact Person : Sylvia
 Designation : Business Development Manager
 Telephone No. : 0757-83050360
 Fax No. : 0757-83901672
 Cell No. : 8613798679332
 Email : guangta0663@gmail.com
 Website : www.guangta.com.cn
 Brand Name : Guangta
 Business Type : MANUFACTURERS
 Products Details : stainless steel coil , stainless steel circle
 Stall No. : **CHINA 14 , Hall 2**

Company Name : **Jindal Stainless Ltd.**
 Address : Jindal Centre, 12 Bhikaji Cama Place, New Delhi-110066
 City : Delhi
 Contact Person : Mr. Rohit Raina
 Designation : Head-Corporate Affairs and Communications
 Telephone No. : 011-41462522
 Fax No. : 91 11 26170691
 Cell No. : 9891977442
 Email : rohit.raina@jindalsteel.com
 Website : http://www.jindalstainless.com/
 Business Type : Manufactureres
 Products Details : Stainless Steel
 Stall No. : **Hall No. 3, Booth 11**

Company Name : **JMB METAL CRAFTS PVT. LTD.**
 Address : 1371, KIRAN MARG, BARKAT NAJA, TONK PHATAK.
 City : JAIPUR-302015 (RAJASTHAN)
 Contact Person : Anil Khandelwal
 Position / Designation : CEO
 Telephone No. : (141)-2595635
 Cell No. : 9829015635, 9414041661
 Email : jmbmetalcraft@gmail.com
 Website : www.jmbmetal.com
 Brand Name : JMB
 Business Type : MANUFACTURERS
 Products Details : Stainless Steel Balustrades, Steel Railings, SS Table Bases, Stainless Steel Doors & many more
 Stall No. : **HALL NO. 2 / BOOTH NO. 84**

Company Name : **J.N.K. METAL INDUSTRIES**
 Address : RICOH, Sameshwar Industrial Area
 City : SIROHI (RAJASTHAN)
 Contact Person : Mr. Bhavesh Kansara
 Designation : PROPRIETORS
 Cell No. : 8469188124
 Email : bkansara.9@gmail.com
 Brand Name : JANAK
 Business Type : MANUFACTURERS
 Products Details : 100% Pure Bronze Utensils
 Stall No. : **Hall No. 4, / Booth 9**

Company Name : **JUPITER MULTISTEEL**
 Address : B/105, Shanti Building No.2, Mathuradas Road Estension, Kandivali (West), Mumbai-400067, Maharashtra.
 City : Mr.Prashant Shah
 Contact Person : Prioprietor
 Designation : Prioprietor
 Telephone No. : 022-28083984
 Fax No. : 022-28621056.
 Cell No. : 9821055785
 Email : jupiterpra@hotmail.com
 Website : www.jupitergroup.co.in
 Brand Name : JUPITER
 Business Type : TRADER AND IMPORTER
 Products Details : Designer Stainless Steel Sheet
 Stall No. : **Hall 3 / STALL 74**

Company Name : **JVL CLASSICWARE**
 Address : 44/8, E K AGRAHARAM STREET, MAHAVEER MARKET, E K AGRAHARAM STREET,
 City : CHENNAI
 Contact Person : VINOD SHAH
 Designation : owner
 Telephone No. : 044-23463456
 Cell No. : 9840026929
 Email : jvl@jvlclassicware.com
 Website : www.jvlclassicware.com
 Brand Name : JVL
 Business Type : Mfrs
 Products Details : HOUSEHOLD
 Stall No. : **STALL 39 / HALL 1**

Company Name : **KAIZEN OVERSEAS**
 Address : C-1/7, GIDC, B/H NATIONAL WATER TANK, Nr APPA HOTEL, AMBICANAGAR ROAD, ODHAV GIDC,
 City : AHMEDABAD
 Contact Person : PADMARAM KHATRI
 Designation : owner
 Telephone No. : 079-22872447
 Cell No. : 9426172090
 Email : kaizenoverseas@gmail.com
 Brand Name : KAIZEN
 Business Type : MFRS
 Products Details : HOUSEHOLD
 Stall No. : **HALL 80 / HALL 1**

Company Name : **KAMAL METAL CORPORATION**
 Address : NO 2 JAGGNATH ESTATE NEAR KANDWARI ROLLING MILL ODHAV
 City : AHMEDABAD
 Contact Person : MR UTTAM RANKA
 Designation : PROPRIOTOR
 Telephone No. : 9978979329
 Cell No. : 9322234878
 Email : karnalmetal2013@gmail.com
 Website : www.kamalmetals.com
 Business Type : IMPORTER /TRADERS
 Products Details : STAINLESS STEEL COILS AND STRIPS
 Stall No. : **HALL 3 / STALL 39**

Company Name : **KASTURI IMPEX**
 Address : 23, KESAVA IYER STREET, CHENNAI
 City : JAGDISH MUTHA
 Contact Person : partner
 Designation : partner
 Telephone No. : 044-23465504
 Cell No. : 9840177796
 Email : kitchensteel@gmail.com
 Brand Name : Kitchen
 Business Type : mfrs & export
 Products Details : Cookware & Tabalware
 Stall No. : **STALL 93 / HALL 1**

Company Name : **ACTIONWARE INDIA PVT. LTD.**
 Address : VILLAGE - DHOLARA, NR - KANGASHIYALI VILLAGE, GONDAL ROAD,
 City : RAJKOT - 360 022
 Contact Person : MR. KISHAN MANVAR
 Designation : V.P. (MARKETING)
 Telephone No. : 91-2827-293552/1
 Fax No. : -
 Cell No. : 91-940 930 9015
 Email : INFO@ACTIONWARE.IN
 Website : WWW.ACTIONWARE.IN
 Brand Name : ACTIONWARE
 Business Type : MANUFACTURERS / EXPORTER / SUPPLIER
 Products Details : KITCHENWARE / HOUSEWARE / CLEANINGWARE
 Stall No. : **STALL 29 / HALL 1**

Company Name : **KERIYA METAL CORPORATION**
 Address : 447/449, MAULANA AZAD ROAD, GOVIND NIWAS, NEAR GOAL DEVAL,
 Contact Person : Mr. NARSINHMAL JAIN, Mr. KAMLESH JAIN
 Designation : PROPRIETORS
 Telephone No. : 022-23810518/23867721/23852184
 Fax No. : 022-23802260
 Cell No. : 9820041319, 9819075570
 Email : keriyametal@live.in
 Business Type : Supplier / Trading Company
 Products Details : Supplier of stainless steel raw materials, industrial raw materials, steel products, stainless steel products and stainless steel components
 Stall No. : **Hall No. 3, / Booth 50**

Company Name : **KEYUR KITCHENWARE**
 Address : UNIT NO. 5, KUNAL INDUSTRIAL ESTATE, GAURAIKADA, NEAR SBI,
 City : AHMEDABAD



City : VASAI - EAST, THANE-401208.
 Contact Person : MR. KEYUR NAGDA / MR. KALPESH NAGDA
 Designation : PARTNER
 Telephone No. : 0250-6054885/6054886
 Fax No. : 0250-2452994
 Cell No. : 9321119762 / 9322234803
 Email : keyurnagda@gmail.com / info@kessentials.com

Website : www.kessentials.com / www.kessentials.in
 Brand Name : KITCHEN ESSENTIALS, HOME ZONE
 Business Type : MANUFACTURERS & EXPORTER

Products Details : STAINLESS STEEL COOKWARE, HARD ANODISED COOKWARE, INDUCTION BASE COOKWARE, PRESSURE COOKERS- INNER LID AND OUTER LID
 Stall No. : **HALL 1 / BOOTH 65**

Company Name : **KING METAL WORKS**
 Address : Unit no.5, Steel Made Indl.Estate, Marol,Maroshi Road, Andheri east, Mumbai - 400 059 {India}
 Contact Person : Mr. Atul Shah / Mr. Kamal Shah
 Designation : Partner / Partner
 Telephone No. : 91-22-40275711
 Fax No. : 91-22-66937988
 Cell No. : 91-9821130070
 Email :

kingmt@vsnl.com;atul@kingmetal.com;kamal@kingmetal.com; sales@kingmetal.com
 Website : www.kingmetal.com
 Brand Name : KMW
 Business Type : Mfgs / Importers / Exporters
 Products Details : Stainless Steel & Aluminium Kitchenware, Tableware, Bar ware, Flatware for Hotel, Restaurants & Homes.

Stall No. : **HALL 1 / BOOTH 5**

Company Name : **KISHAN ENTERPRISE**
 Address : PATEL INDL. AREA, RIDDHI SIDDHI SOCIETY, OPP. RAILWAY OVERBRIDGE, NR. NATIONAL HOGHWAY 8-B, KOTHARIYA
 City : RAJKOT
 Contact Person : JAYESH PARSANA
 Designation : Propirter
 Cell No. : 9825075094
 Email : kishan.enterprise@gmail.com
 Brand Name : KISHAN
 Business Type : MFRS
 Products Details : KITCHENWARE PRODUCTS
 Stall No. : **STALL 53 / HALL 1**

Company Name : **LALIT CASTING**
 Address : SANSKAR SOCIETY, STREET NO. 1, NEAR SHREE HARI IND. AREA, NH-8B, RAJKOT
 City : RAJKOT
 Contact Person : HANSARAJ PATEL
 Designation : PARTNER
 Telephone No. : 0281-6582842
 Cell No. : 8511000851
 Email :

HONESTKITCHENWARE@GMAIL.COM
 Website : HONESTKITCHENWARE.COM
 Brand Name : HONEST
 Business Type : MANUFACTURING, EXPORT
 Products Details : STEEL & BRASS SEV SANCHI, KHALBATTA, CHILLY CUTTER, AND MORE THEN 100 PRODUCT
 Stall No. : **HALL NO -1, STALL NO- 3**

Company Name : **LAVISH APPLIANCES**
 Address : 9-SORATHIYA WADI, ARADHANA CHOWK, RAJKOT - 360002.
 City : RAJKOT - 360002.
 Contact Person : JAYESH BHANDERI
 Designation : PROPRIETOR
 Telephone No. : 0281 - 2234081
 Fax No. : -

M.09898103222
 Cell No. : info@delightkitchenware.com
 Email : info@delightkitchenware.com
 Website : www.delightkitchenware.com
 Brand Name : DELIGHT KITCHENWARE
 Business Type : MANUFACTURERS
 Products Details : KITCHENWARE
 Stall No. : **STALL 69 / BOOTH NO. 1**

Company Name : **LAXCON STEELS LIMITED**
 Address : 2nd Floor,Rajvi Arcade,Opp.Gurukul Temple,Memnagar Ahmedabad-380052,Gujarat
 City : Ahmedabad-380052,Gujarat
 Contact Person : VINOD GUPTA
 Designation : Director
 Telephone No. : 079-40007600
 Fax No. : 7940007666
 Cell No. : 9811029303
 Email : vinod@gopalgroup.com
 Website : www.gopalgroup.com
 Brand Name : LAXCON
 Business Type : Manufacturing of Stainless,Special and Alloy Steel Long Products

Products Details : Manufacturing of Stainless,Special and Alloy Steel Long Products
 Stall No. : **Hall No.3 / Stand No.17**

Company Name : **M.A.ENTERPRISES**
 Address : 508, G.I.D.C. PHASE IV, MEHMDABAD HIGHWAY ROAD,VATVA, AHMEDABAD-382440
 City : AHMEDABAD-382440
 Contact Person : Mr.Ashok Bhansali
 Designation : Owner
 Telephone No. : 079-25831384, 25831385
 Cell No. : 9825030604
 Email : maenterprisesadi@gmail.com, enquiry@ma-enterprises.com, www.ma-enterprises.com

Website : www.ma-enterprises.com
 Brand Name : MA
 Business Type : MANUFACTURERS
 Products Details : CIRCLE, SHEETS, PIPE, TUBE, HOME APPLIANCES, UTENSILS, KITCHENWARE, CUTLERY, HARDWARE, SUBMERSIBLE PUMPS, LPG STOVE
 Stall No. : **HALL NO. 3 / BOOTH NO. 15**

Company Name : **Magppie International Ltd.**
 Address : 153, A B & C, EPIP Extn., Kundli, Distt. Sonipat, Haryana 131028
 City : Sonipat
 Contact Person : Parag Tandon
 Designation : Vice President
 Telephone No. : +91-130-2219901 to 07
 Fax No. : +91-130-2219909
 Cell No. : +91-9873918002
 Email : parag@magppie.com
 Website : www.magppieindia.com
 Brand Name : Magppie; House & Home
 Business Type : Manufacturer, exporter and trader
 Products Details : Utencils, home décor, bar products
 Stall No. : **Hall no.1 / Stall no. 16**

Company Name : **MAHAVIR STEEL INDUSTRY**
 Address : PLOT NO-138, RAFALESHWAR GIDC, NATIONAL HIGHWAY NO-8-A,
 City : MORBI
 Contact Person : SIDHARTH TIWARI

Designation : Manager
 Telephone No. : 02822-292033
 Cell No. : 9727395777
 Email :

mahendrajain022@rediffmail.com, sidharthtiwari1982@gmail.com
 Website : www.adityasink.com
 Brand Name : ADITYA
 Business Type : MFRS
 Products Details : SS KITCHEN SINKS
 Stall No. : **STALL 82 / BOOTH 2**

Company Name : **MANIBHADRA INDUSTRIES**
 Address : 45 RAGHUNAYKULU STREET, I FLOOR, PARK TOWN CHENNAI - 600003
 City : CHENNAI - 600003
 Contact Person : AMBALAL B JAIN
 Designation : PROPERITOR
 Telephone No. : +91 44 25355096; +91 44 23463616
 Cell No. : +91 9884516492
 Email :

ANUPAMSTEEL@OUTLOOK.COM
 Website : WWW.ANUPAMSTEEL.COM
 Brand Name : 'ANUPAM'
 Business Type : MANUFACTURER
 Products Details : STAINLESS STEEL & HARD ANODIZED - KITCHEN AND COOKWARE; HOUSEHOLD UTENSILS;
 Stall No. : **STALL 62 / HALL 1**

Company Name : **MANISH METAL**
 Address : 44/8, E K AGRAHARAM STREET, MAHAVEER MARKET, E K AGRAHARAM STREET, CHENNAI
 City : CHENNAI
 Contact Person : LALIT SHAH
 Designation : owner
 Telephone No. : 044-23463456
 Cell No. : 9840076638
 Email : jvl@jvlclassicware.com
 Website : www.jvlclassicware.com
 Brand Name : JVL
 Business Type : Mfrs
 Products Details : HOUSEHOLD
 Stall No. : **39-A / HALL 1**

Company Name : **MARC WORLD**
 Address : NO.313, MINT STREET, (NEAR EKAMBARESHWAR AGRAHARAM), CHENNAI
 City : CHENNAI
 Contact Person : SANJAY JAIN
 Designation : Propirter
 Telephone No. : 044-23468835
 Cell No. : 9884135199
 Email : marcworld25@yahoo.in
 Brand Name : MARC
 Business Type : Mfrs
 Products Details : SS UTENSILS
 Stall No. : **STALL 40 / HALL 1**

Company Name : **maru metal industries**
 Address : e/11 doshi udyog nagar, jai ambe road, bhayander (e) dist thane-401105
 City : mumbai
 Contact Person : kanti p maru
 Designation : propritor
 Telephone No. : 022 28047503 & 02239316776
 Cell No. : 09322047503 & 09920017503
 Email : marumetal@yahoo.co.in
 Brand Name : maru
 Business Type : manufacture
 Products Details : stainless steel utensils

Company Name : **MAYUR INDUSTRIES**
 Address : No. 64, Theyagappa Chetty Street, Korukupet CHENNAI-600021
 City : CHENNAI-600021
 Contact Person : Arun Vikam
 Designation : Partner

Telephon No. : 044 25923145, 044 25923145
 Cell No. : 99400 37764
 Email : mayurutensils@hotmail.com
 Website : www.mayurkitchenware.com
 Brand Name : Mayur, Modware
 Business Type : MANUFACTURERS
 Products Details : Stainless Steel kitchenware , serving pots and tableware
 Stall No. : **Hall 1 / BOOTH 91-92**

Company Name : **MEDITEK INTERNATIONAL LIMITED**
 Address : C - 43, DSIDC Packaging complex, Kirti nagar, NEW DELHI-110015
 City : NEW DELHI-110015
 Contact Person : Rajesh Ghandhi, Daleep Pandita
 Designation : PROPRIETORS
 Telephone No. : 011-41420776, 25927776, 25927635
 Cell No. : 9811127408, 9910424377, 9811500524
 Email : meditekinternational@yahoo.com
 Website : www.meditekinternational.com
 Brand Name : MEDITEK
 Business Type : Manufacturing & Trading
 Products Details : Printing Machinery
 Stall No. : **Hall No. 2 / Booth 8**

Company Name : **MEERA METAL INDUSTRIES**
 Address : PLOT NO. 134, G.I.D.C., BEHIND BHAGWATI FOUNDRY, ODHAV,
 City : AHMEDABAD-382415
 Contact Person : MOHAN CHOUDHARY
 Designation : Owner
 Telephone No. : 079-22890511, 55450051
 Cell No. : 9879791777, 9825323275
 Email : meerametalind@gmail.com
 Brand Name : Meera
 Business Type : Manufacture
 Products Details : S. S. utensils, kitchen-ware and house ware, Kadai & Steamer, Dinner set, Dulhan set, Handi, Lemon set, Pawali, Beda, Bucket, Canister, Top, Kadai, khumcha, Mathar, MK Thal, Gunj, Belly, Sauce pan etc, S.S. Pipes, Tubes, Sheet, Plate, Coil, S.S. & M.S. Fitting

Stall No. : **Hall No. 4 / Booth no. 24**

Company Name : **MEHTA CAD CAM SYSTEMS PVT. LTD.**
 Address : 4 & 5, 2ND FLOOR, SUMEL COMPLEX,OPP. GNFC INFO TOWER, NEAR TEJ MOTORS, SARKHEJ-GANDHINAGAR ROAD,
 City : AHMEDABAD - 380059, GUJARAT
 Contact Person : Mr. DIWAKAR MISHRA
 Designation : MARKETING HEAD
 Telephone No. : 079-26840551/52
 Fax No. : 079-26840554
 Cell No. : 9227678044
 Email :

Website : exhibition@mehtainida.com, mis hra@mehtaindia.com
 Website : www.mehtaindia.com
 Brand Name : MEHTA
 Business Type : MANUFACTURER AND SUPPLIER
 Products Details : MANUFACTURER OF PLASMA CUTTING MACHINES, LASER CUTTING MACHINES AND LASER MARKING MACHINES.
 Stall No. : **Hall 2 , Stall 13**

Company Name : **MEHTA ENTERPRISES (LUCKY)**
 Address : E-352 MGC Sangaria

City : JODHPUR
 Contact Person : RAMAN BHAI MEHTA, DHANPAL MEHTA
 Designation : Propirter
 Cell No. : 9460775079, 9929130222
 Email : mehta.dhanpal@yahoo.com
 Website : www.luckystainlesssteel.com, www.mehtaenterprises.in
 Brand Name : LUCKEY
 Business Type : mfrs
 Products Details : HOUSEHOLD
 Stall No. : **STALL 51 / HALL 1**

Company Name : **METAL & MACHINERY**
 Address : 321, G.V.M.M. COMPLEX, ODHAV,
 City : AHMEDABAD-382145
 Contact Person : Mr. Heerachand Hundia, Mr. Ravi Hundia,
 Designation : PROPRIETORS
 Telephone No. : 079-25624850, 25620008
 Cell No. : 9825008467, 9825006608, 9426020304
 Email : ravihundia@rediffmail.com, ravihundia@gmail.com, garudagroup@rediffmail.com
 Website : www.metalsnmachinery.com
 Brand Name : METAL AND MACHINE
 Business Type : MANUFACTURERS
 Products Details : TUB MILL MACHINERY, MFR
 Stall No. : **Hall No. 3, / Booth 8**

Company Name : **METAL BULLETIN (SMR GmbH)**
 Address : Innovation Center, Kohlplatz 7, 6600 Reutte
 City : AUSTRALIA
 Contact Person : Mr. Markos Mall, Mr. Patrica Mall
 Telephone No. : (+43) (5672) 72737
 Fax No. : (+43) (5672) 72737-99
 Email : sjones@metalbulletin.com, charles.lee@metalbulletinasia.com
 Website : www.smr.at

Company Name : **METAL COOKWARE**
 Address : 149, VELIAVALYA VILLAGE, VICHOR ROAD, MANALI NEW TOWN,
 City : CHENNAI
 Contact Person : Sanjay Jain, Sudhir Bhai
 Designation : Partner Director
 Telephone No. : 044-29010082, 29020103
 Cell No. : 9840257373
 Email : metalcookware@gmail.com
 Website : WWW.SONUINDIA.COM
 Brand Name : SONU
 Business Type : MANF & SUP
 Products Details : COOKWARE, NOT-STICK SCORPIO
 Stall No. : **HALL No.1 / BOOTH 14**

Company Name : **Metal Tradres (India) Pvt. Ltd**
 Address : 685 Chowk Bara Tooti, Sadar Bazar, Delhi-6
 City : Delhi
 Contact Person : Mr. Aakash Gupta
 Designation : Director
 Telephone No. : 011-23683271 to 76
 Fax No. : 011-23538557
 Cell No. : 9810171947
 Email : mtiml@gmail.com
 Website : www.metaltradersindia.co.in
 Business Type : Importers
 Products Details : Nickel, Silicon, Tin, Lead etc.
 Stall No. : **Stall 3 / Booth 66**

Company Name : **METALLOY PRIVATE LIMITED**
 Address : H-49, 1st Floor, Gali No. 3, Laxmi Nagar,
 City : NEW DELHI
 Contact Person : Mr. M.K. Agarwal / Mr.

Designation : D.R.Singh
 : Managing Director / AGM-MARKETING
 Telephone No. : 0121-2440083
 Fax No. : 021-2512279
 Cell No. : 9971045330, 7351211666
 Email : metalloy.in@gmail.com, info@metalloy.in
 Website : www.metalloy.in
 Brand Name : METALLOY
 Business Type : MANUFACTURERS
 Products Details : STAINLESS STEEL TUBES AND PIPES
 Stall No. : **STALL NO. 81/ HALL NO. 3**

Company Name : **METROLINE INDUSTRIES (B. N. METAL)**
 Address : NO. 12, PADMAVATHY STREET, KRISHNAMOORTHY NAGAR, KODUNGAIYUR,
 City : CHENNAI-600018
 Contact Person : Mr. SUNIL SANGHVI, Mr. GAUTAM BHAI
 Designation : PROPRIETORS
 Telephone No. : 044-25359243, 25331762
 Cell No. : 9840743485, 9444012872, 9444079978
 Email : info.metroline@gmail.com, metrolineindustries@gmail.com
 Brand Name : METROLINE
 Business Type : Manufacturers
 Products Details : S.S. Cutlery, Utensils
 Stall No. : **Hall No. 1, / Booth 41**

Company Name : **MICRO STEEL**
 Address : SHOP NO 9, SILVER COMPLEX, OPP R.M.C. BUILDING (EAST ZONE), BHAVNAGAR ROAD
 City : RAJKOT
 Contact Person : INDRABHAI
 Designation : partner
 Cell No. : 9925044700
 Email : groupofmahalaxmi@gmail.com
 Website : www.microsteels.com
 Brand Name : MICRO STEEL
 Business Type : MFRS
 Products Details : SS WIRES & TUBES
 Stall No. : **STALL 75 / HALL 3**

Company Name : **MILOVE KOTHARI**
 Address : 215, Chandraprabhu complex, Near Sardar Patel Statue, Naranpura
 City : AHMEDABAD
 Cell No. : 9998007716
 Stall No. : **STALL 77 / BOOTH 2**

Company Name : **MIRA STEELS**
 Address : 162-A, BALKRISHNA NIWAS, PANJRAPOLE RD, MUMBAI-400002
 City : MUMBAI-400002
 Contact Person : PRAVIN RAJAWAT/BHARAT RAJAWAT
 Designation : PARTNER
 Telephone No. : 022-22425695/7373
 Fax No. : 022-22428501
 Cell No. : 09892728880/07738549049
 Email : sales@mirasteels.com, nrajawat@hotmail.com
 Website : www.mirasteels.net, www.mirasteels.com
 Brand Name : MIRA
 Business Type : manufacturers & exporters of hotel & catering products
 Products Details : HALL 4 / STALL 18-19

Company Name : **MINOX METAL PVT LTD**
 Address : 7, P.C.lane, S.P.Road cross, Bangalore - 560002, India
 City : BANGALORE
 Contact Person : Mr Vijay Bhandari
 Designation : Director
 Telephone No. : 080- 41325007
 Fax No. : 080 22217144



Cell No. : 9845007007
 Email : info@minoxmetal.com
 Website : www.minoxmetal.com
 Brand Name : MINOX
 Business Type : STAINLESS STEEL PROCESSING AND SERVICE CENTER

Products Details : SS COILS, SHEETS, STRIPS, PIPES, TUBES AND DESIGNER SHEETS.

Stall No. : **STALL NO.3 IN HALL - 3**

Company Name : **MITTAL CORP LIMITED**
 Address : ABHAY PRASHAL, RACE COURSE ROAD
 City : INDORE - 452 003 (M.P.)
 Contact Person : Mr. KARAN MITTAL
 Designation : MANAGING DIRECTOR
 Telephone No. : 0731 2437500
 Fax No. : 0731 2430408
 Cell No. : Mr Shiv Kumar: 09893417000, 09425322762 / Mr. Rajesh Barla 09755595547

Email : info@mittalcorp.net
 Website : www.mittalcorp.net
 Brand Name : MITTAL
 Business Type : MANUFACTURERS
 Products Details : Rod in Coils, Rounds, Billets in Stainless Steel / Alloy Steel / Carbon Steel grades, QTR/QTB (Thermo Mechanically Treated) Reinforcement Bars
 Stainless Steel Reinforcement Bars

Stall No. : **STALL 12 - Hall 3**

Company Name : **M.L.G. STEELS/ SANJAY SALES CORPORATION**
 Address : A-50/1, Muni Lal Chowk, Wazirpur Industrial Area,
 City : NEW DELHI-110001
 Contact Person : Mr. Muni Lal Gupta, Mr. Sanjay Gupta
 Designation : PROPRIETORS
 Telephone No. : 011-27377951
 Cell No. : 9810195763
 Email : mlgsteels@yahoo.co.in
 Business Type : MANUFACTURERS
 Products Details : RAW MATERIAL, SHEETS, CIRCLE

Stall No. : **Hall 3, / Booth 19**

Company Name : **M. M. STEEL & ALLOYS**
 Address : 75/76, Krishna Ind. Estate, Nr. Radheshyam Estate, Opp. G.V.M.M. Odhav,
 City : AHMEDABAD (GUJ)-382415
 Contact Person : Goutam Sheth, Pravin Kumar, Mahaveer Kumar
 Designation : PROPRIETORS
 Telephone No. : 079-22900690,
 Cell No. : 9327003335, 9428593645
 Email : pravinsheth.2009@gmail.com, mmsteelgroups@gmail.com

Business Type : MANUFACTURERS
 Products Details : SS SHEET, COIL, CIRCLE, PATTI, PATTI
 Stall No. : **Hall No. 3, / Booth 61**

Company Name : **M.P. INDUSTRIES**
 Address : Plot No. 10/2, Phase 1st GIDC, Vatava, Near Vatava Rly Crossing
 City : AHMEDABAD-382445
 Contact Person : Mr.Kushal Raj Bhansali
 Designation : Owner
 Telephone No. : 079-25890337
 Cell No. : 09825037067, 09898507235
 Email : kushalvbhansali@hotmail.com
 Website : www.stainlesssteelsheet.co.in
 Business Type : MANUFACTURERS
 Products Details : Rolling Mills, Stainless Steel

Sheet, Patta-Patti
 Stall No. : **Hall No. 3 / Booth No. 16**

Company Name : **MPEE KITCHENETTE P LTD**
 Address : #13, Attibele Industrial Area, Near Guestline Hotel
 City : Bangalore -562 107
 Contact Person : Mr Prakash Bhansali
 Designation : Managing Director
 Telephone No. : 080-27808281
 Fax No. : 080-27820035
 Cell No. : 9686201011
 Email : info@mpeekitchenette.com
 Website : www.mpeekitchenette.com
 Brand Name : MASTER
 Business Type : Manufacturers
 Products Details : Small Kitchen Appliances like Pressure Cookers Aluminium and Stainless Steel, LPG Stoves, LPG Glass Tops, Non Stick Cookware, Mixer and Grinders, Induction Cooktops, Wet Grinders, Rice Cookers, Electric Coil Stoves, Immersion Heaters, Roti Makers, Dry Irons

Stall No. : **Hall No. 1 / Booth No. 82**

Company Name : **MRB PIPE & TUBES PVT LTD**
 Address : 8, Lala Bholelal Ni Chafi, Nagarvel Hunuman Road, Keval Kanta Road, Rakhial, Near Keval Kanta Road,
 City : AHMEDABAD-380023
 Contact Person : Mr. MAHENDRA BHANDARI
 Designation : Owner
 Telephone No. : 079-22746203
 Cell No. : 9879766644
 Email : mrbpipe@yahoo.com
 Website : http://www.mrbpipes.com/
 Brand Name : MRB
 Business Type : Manufacturers & Traders
 Products Details : Stainless Steel, Steel TMT Bars, Pipes and Wires, Steel Tubes and Pipes, Wire

Stall No. : **Hall No. 3, / Booth 82**

Company Name : **MUKESH INDUSTRIES PVT. LTD.**
 Address : # 65, Vyasarpadi Co-op. Industrial Estate, E.H. Road, Vyasarpadi,
 City : CHENNAI (T.N.)
 Contact Person : Gavish Jain
 Telephone No. : 044-42809873, 25510213
 Cell No. : 9840786105
 Email : info@pigeonindia.in
 Website : www.pigeonindia.in
 Brand Name : PIGEON
 Business Type : MANUFACTURERS
 Products Details : Serving Dish, Lunch Sets, Cookwares, Idly Cooker, Multi Kadai, Milk Boiler

Stall No. : **Hall No. 1/ Booth No., 21**

Company Name : **M.V. METAL**
 Address : 44/3, RAGHUNAYAKULU STREET, PARK TOWN,
 City : PARK TOWN, CHENNAI - 600 003.
 Contact Person : VIKRAM KUMAR M JAIN
 Designation : MANAGING DIRECTOR
 Telephone No. : 044-2346 5243/8673
 Fax No. : 044 - 25552426
 Cell No. : 7418045000/9840206720
 Email : vikram@mvmmetal.in/maxxelinda@yahoo.com

Website : www.mvmmetal.in/www.maxxelin dia.in
 Brand Name : RUDRA/MANGALDEEP & RANCHER
 Business Type : MANUFACTURE & EXPORTER SUPPLIERS AND INDIA

Products Details : S.S.DISHES, BOWLS, TRAYS, PLATES, HOUSEWARES, HOTEL WARES & GIFT ITEMS
 Stall No. : **HALL 1 / STALL 3A**

Company Name : **NAKODA METALIKS**
 Address : 117, Vidya Industrial Estate, Nr. Srirang Chemicals, Ambicanagar Road, Odhav
 City : AHMEDABAD (GUJRAT)-382415
 Contact Person : Mr. Lalit
 Designation : PROPRIETORS
 Telephone No. : 079-22973006
 Cell No. : 9662949462
 Email : nakodametalik@gmail.com, nakodametal@gmail.com
 Business Type : MANUFACTURERS
 Products Details : STAINLESS STEEL UTENSILS
 Stall No. : **Hall No. 1, / Booth 28**

Company Name : **NAKODA STEELS**
 Address : F-706 NEAR KRASHNA DHARAM KANTA GALI NO. 6, BASNI 2ND PHASE
 City : JODHPUR
 Contact Person : JINENDRA JI
 Designation : Owner
 Cell No. : 9414130699
 Email : jinen.nakoda.9@gmail.com
 Website : www.Nakodasteel.com
 Brand Name : Nakoda
 Business Type : Manufacture
 Products Details : All . Kitchenware Items.
 Stall No. : **Hall No. 4, / Booth 5**

Company Name : **NAMAN ENTERPRISES**
 Address : 619/A-1, OPP MUTHOOT FINANCE, NEAR TIKONA PARK,
 City : MAIN LONI ROAD, SHAHDARA, DELHI - 110032
 Contact Person : MR. NAMAN AGARWAL
 Designation : SALES AND BUSINESS DEVELOPMENT HEAD
 Telephone No. : 011-22575647
 Fax No. : 011-22575647
 Cell No. : 0-9871917917,9310429392
 Email : naman@padprintingmachine.net

Website : www.padprintings.com
 Brand Name : ELECTROTECH
 Business Type : MANUFACTURER OF PRINTING MACHINES
 Products Details : PAD PRINTING MACHINES, METAL MARKING MACHINES.
 Stall No. : **STALL NO. 60/HALLNO. 2**

Company Name : **NAMI STEEL PVT LTD**
 Address : Opp. Chharodi Railways Station, Tata Nano- Ford road, Ta- Sanand
 City : Ahemedabad
 Contact Person : PARIXIT PATEL/VINOD DESAI/GAURAV SHARMA
 Designation : MARKETING
 Telephone No. : 079-66051212
 Cell No. : 9998500005
 Email : parixit@namiparixit.com
 Website : www.namiparixit.com www.namisteel.com

Brand Name : Nami
 Business Type : Manufacturer
 Products Details : SS FLAT, ROUND, HEX, SQUARE, ANGLE AND CHANNEL OF ALL GRADES.
 Stall No. : **HALL 3/ STALL 58**

Company Name : **NAVBHARATH METAL CORPORATION**
 Address : 4, D.R. lane, S.P. road cross, BANGLORE (KARNATAK)-560001
 City : BANGLORE (KARNATAK)-560001
 Contact Person : Mr. Naveen B. Patel

Designation : PROPRIETORS
 Cell No. : 9342588433, 9448767829
 Email : navbharathmetalcorporation@gmail.com
 Business Type : Manufacturers & Traders
 Products Details : St. steel , Ind. Raw mat. Refrigerators copper coils in All range From 1/8" to 1" S.S.
 Stall No. : **Hall No. 2 / Booth 51**
 Company Name : **NAVKAER METAL PVT.LTD**
 Address : PLOT NO.342,G.I.D.C. ODHAV, AHMEDABAD
 City : AHMEDABAD
 Contact Person : TARACHAND JAIN
 Designation : OWNER
 Telephone No. : 22871016 , 22875515
 Cell No. : 9824051515
 Email : trjain@gmail.com
 Brand Name : Navkaer
 Business Type : Manufacture
 Products Details : Kitchenware , Hotelware , items
 Stall No. : **STALL 67 / HALL 1**
 Company Name : **NESTWELL PRODUCTS**
 Address : SOMNATH INDUSTRIAL STREET NO.2, KOTHARIYA IND. AREA, OPP KRISHNA PARK HOTEL, GONDAL ROAD BY PASS
 City : RAJKOT
 Contact Person : VASANTBHAI
 Designation : Propirter
 Telephone No. : 0281-6592477
 Cell No. : 9824413935
 Email : nestwellkitchenware@gmail.com , info@nestwellkitchenware.com
 Website : www.nestwellkitchenware.com
 Brand Name : NESTWELL
 Business Type : MFRS
 Products Details : KITCHENWARE
 Stall No. : **STALL 27 / HALL 1**
 Company Name : **NEW STEEL CENTRE / ARISTOCRAT STEEL**
 Address : No 38, Near Kandasamy Temple, Raghu Nayakulu Street, Park Town,
 City : CHENNAI (T.N.)-600003
 Contact Person : Tekchand Jain, Praveen Kumar, Mahipal Jain
 Designation : PROPRIETORS
 Telephone No. : 044-25350326, 23463253
 Cell No. : 9444053206
 Email : newsteelcentre@rediffmail.com, info@aristocratsteel.com, mahipz@gmail.com
 Website : www.aristocratsteel.com
 Brand Name : ARISTOCRAT
 Business Type : MANUFACTURERS & TRADERS
 Products Details : S.S. Tea Can , Hot Pot, Water Filter, Stock Pot, Idly cooker
 Stall No. : **Hall No. 1 / Booth 57**
 Company Name : **N-Mart Industries**
 Address : 374/1, GIDC , Near Hanuman Mandir, Makarpura
 City : Vadodara
 Contact Person : Nimesh Gandhi
 Designation : Proprietor
 Telephone No. : 0265-2635761
 Fax No. : 0265- 2654161
 Cell No. : 9898064100
 Email : nmart@nmartindustries.com
 Website : www.nmartindustries.com
 Brand Name : NMART
 Business Type : Manufacturer & Exporter
 Products Details : Stainless Steel and silicon handles for cookware
 Stall No. : **HALL 4 / STALL 22**
 Company Name : **OSWAL CHEMICALS**

Address : C/105, 1st FLOOR ,GCP BUSINESS CENTRE , OPP- MEMNAGAR FIRE STATION, NAVRANGPURA
 City : AHMEDABAD. 380009 (GUJRAT)
 Contact Person : NIRAV V MEHTA
 Designation : DIRECTOR
 Telephone No. : 079-26473601,02
 Fax No. : 079-26473617
 Cell No. : 9824112299
 Email : purchase@oswalchemical.com, nirav@oswalchemical.com
 Brand Name : OSWAL CHEMICALS
 Business Type : DEALER
 Products Details : HYDRO FLUORIC ACID CHEMICALS
 Stall No. : **HALL-2 / STALL 22**
 Company Name : **Outokumpu India Private Limited**
 Address : 609-612, Hemkunt Tower, Nehru Place, New Delhi-110019 India
 City : New Delhi
 Contact Person : Mr. Yatinder Suri
 Designation : Country Head
 Telephone No. : 011-46518444
 Fax No. : 011-46518439
 Cell No. : 9818120952
 Email : yatinder.suri@outokumpu.com
 Website : www.outokumpu.com
 Brand Name : Outokumpu India Private Limited
 Business Type : Sales and Marketing Subsidiary of the Outokumpu Group
 Products Details : Stainless Steel coils , sheets , plates , long products and welded tubulars
 Stall No. : **Booth -7, Hall - 3**
 Company Name : **Panchmahal Steel Limited**
 Address : GIDC Industrial Estate, Dist, Panchmahals
 City : Kalol - 389330 INDIA
 Contact Person : Mr. Hanish Malhotra
 Designation : Director -Marketing
 Telephone No. : 02676 304777
 Fax No. : 02676 304888
 Email : sales@panchmahalsteel.co.in
 Website : www.panchmahalsteel.co.in
 Brand Name : as per the attachment
 Business Type : Manufacturers / Exporter
 Products Details : Stainless Steel Long Products
 Stall No. : **Hall no. 3 / Booth no. 36**
 Company Name : **PANCHRATAN STEELS PVT.LTD**
 Address : PLOT NO. 40, 41, 42 GIDC ESTATE, RANASAN, MAHUDI ROAD, NR, ASHRAM CHOKDI, TA. VIJAPUR, DIST. MEHSANA
 City : GUJARAT
 Contact Person : MR.KAMLESH SHAH
 Designation : Manager
 Cell No. : 9687300222
 Email : info@panchratansteels.com
 Website : www.panchratansteels.com
 Brand Name : PSPL
 Business Type : mfrs & export
 Products Details : RAW MATERIAL
 Stall No. : **BOOTH 77 / HALL 3**
 Company Name : **PARMO WELDING MACHINERY P LTD**
 Address : Atika Ind. Area Street. No. 2 Opp. Kishan Weight Bridge Dheber Road
 City : Rajkot
 Contact Person : Mahesh. Bhai , Harish Bhai
 Designation : Owner
 Cell No. : 9824732039 , 9824480065
 Email : paras@parmoelectro.com
 Website : www.parmoelectro.com
 Brand Name : Paras

Business Type : Manufacture
 Products Details : Soloring, Machine , Electro Dying ovens Voltage Buster
 Stall No. : **BOOTH 70 / HALL 2**
 Company Name : **PARSHVA INDUSTRIES**
 Address : 13/KOHINOOR INDUSTRIAL ESTATE NEAR VIRVANI ESTA W,EXPHIGHWAY
 City : GOREGAON (EAST) MUMBAI 400063
 Contact Person : MR. MITUL SHAH , MR. NIRMAL SHAH
 Designation : PROPRIETER
 Telephone No. : 022 29270207 , 09320081188
 Cell No. : 9867165494
 Email : parshvagroup13@yahoo.com
 Website : www.indiamart.com/stenso
 Brand Name : STENSO
 Business Type : MANUFACTURER
 Products Details : INSULATE HOT POT & TIFFIN SOFTLINE LUNCH BOX & TIFFINS
 Stall No. : **BOOTH 2 / HALL 1**
 Company Name : **PHEONIX APPLIANCES PRIVATE LIMITED**
 Address : 405.ASHIRWAD BLDG, AHMEDABAD STREET,CARNAC BUNDER,MASJID (E)
 City : MUMBAI-400009
 Contact Person : MR. DINESH KIRAN AGGARWAL
 Designation : DIRECTOR
 Telephone No. : 022-66332479 /23486407
 Fax No. : 022-23488964
 Cell No. : +91 9820308971
 Email : dka@diamondsink.in
 Website : www.diamondsink.in
 Brand Name : DIAMOND
 Business Type : MANUFACTURERS
 Products Details : STAINLESS STEEL KITCHEN SINKS,WASH BASINS & TILE
 Stall No. : **BOOTH 78 / HALL 3**
 Company Name : **PIGEON INDUSTRIES PVT LTD**
 Address : 65-66, Vyasarpadi Co-op Ind. Estate, E.H. Road, Vyasarpadi Chennai - 600 039
 City : Chennai - 600 039
 Contact Person : PRASHANT JAIN
 Designation : Director
 Telephone No. : 044-42809873 / 25510213
 Fax No. : NA
 Cell No. : 8189838383
 Email : info@pigeonindia.in
 Website : www.pigeonindia.in
 Brand Name : Pigeon, u10sils
 Business Type : Manufacturers & Marketing of Stainless Steel Products
 Products Details : utensils and Kitchenware
 Stall No. : **Hall - 1 / Stall 12**
 Company Name : **PIONEER FORGE & FITTINGS**
 Address : NO 8 NANAWATI ESTATE NEAR KEWAL KANTA RAKHIAL AHMEDABAD
 City : AHMEDABAD
 Contact Person : MAHENDRA B MAHETA
 Designation : Owner
 Telephone No. : 9033904455
 Email : pioneerforgefittings@gmail.com
 Brand Name : Biopear
 Business Type : Manufacture
 Products Details : Steel Plainzes & Patta Sheet.
 Stall No. : **HALL 3 / STALL 42**
 Company Name : **P N ENTERPRISES**
 Address : 100,B.T.COMPOUND,MALAD (E),MUMBAI-400 064,India,
 City : MUMBAI
 Contact Person : NITIN SHAH / MITESH SHAH

Designation : PROPERITOR
 Telephone No. : 91-22-28440304
 Cell No. : 91-9892093139 / 91-9892243853
 Email : pnenterprises@rediffmail.com
 Website : www.pnenterprises.com
 Brand Name : PN
 Business Type : MANUFACTURER
 Products Details : KITCHEN WARE
 Stall No. : **Stall 74 / Hall 1**

Company Name : **Prakash Printers & Coaters Pvt LTD**

Address : 4/A/2, Jay Ambe Estate Nr Navneet Prakashan B/H Mukti Foundry Sukhramnagar Ahmedabad-380023
 City : Ahmedabad
 Contact Person : Mr. Prakash T. Shivilani / Mr. Mayur T. Shivilani

Designation : Director/Director
 Telephone No. : 079-22760043
 Fax No. : -
 Cell No. : 9825066641/9879766641
 Email : Prakash Printers & Coaters Pvt LTD

Website : www.prakashprinters.com
 Brand Name : Prakash Printers & Coaters Pvt LTD

Business Type : Manufacturers Sticker Label
 Products Details : Mfg. of self Adhesive Labels & Sticker

Stall No. : **Hall-1/ Stall 52**

Company Name : **Prasum Metals Pvt Ltd**

Address : 1st Floor, Ajanta Complex, Guest House Road, Morbi - 363 641

City : Morbi
 Contact Person : Mr. Vishal Patel
 Designation : Director
 Telephone No. : 91 2822 285585/285575
 Fax No. : 91 2822 285595
 Cell No. : 91 96876 85575

Email : info@prasummetals.com
 Website : www.prasummetals.com
 Brand Name : Prasum Metals Pvt Ltd
 Business Type : Manufacturer & Exporter
 Products Details : Manufacturer & Exporter of Stainless Steel Wires, Stainless Steel CORE, TIG & MIG Wires, Stainless Steel Bright Bars

Stall No. : **Hall 3 / Stall 44**

Company Name : **PRESSMAN PRESS INDUSTRIES**

Address : 30-B, GOA-IDC, SOMNATH ROAD DAMAN -396 210

Address 2 : MUMBAI ADDRESS: B/6, NATAL ESTATE, CHANDIVALI ROAD, OFF SAKIVIHAR ROAD, SAKINAKA, MUMBAI-400 072

City : DAMAN
 Contact Person : Mr. V.K.B. SUBRAMANIAN, Mr. MOHAN

Designation : PARTNER
 Telephone No. : 9920065714 / 982006571, Mr. SATISH: 9820065715, Mr. MOHAN: 9833121476

Fax No. : 022-28475662
 Cell No. : 022-28470790 / 28475662 / 28474094

Email : pressman@vsnl.net, pressmanpressindustries@gmail.com

Website : www.pressmanpress.com
 Brand Name : PRESSMAN / ANCHOR
 Business Type : MANUFACTURER & EXPORTER

Products Details : DEEP DRAWING PRESS AND ACCESSORIES

Stall No. : **Hall 2 / Booth 2**

Company Name : **PRESS ROOM AUTOMATION AND FEED FIXTURES (INDIA) PVT. LTD.**

Address : PLOT NO. C-9, ANAND NAGAR, M.I.D.C., ADDL. AMBERNATH INDUSTRIAL AREA, AMBERNATH (EAST), DIST. THANE

City : THANE
 Contact Person : MR. PARIN L KHONA

Designation : SALES EXECUTIVE
 Telephone No. : OFF :- +91 22 25471016 / 2029, FACT :- +91 251 2621972 / 1976.

Fax No. : :- +91 251 2621972 / 1976.
 Cell No. : :- +91 93229 51554

Email : info@pressroomautomation.net
 Website : www.powerpressline.net
 Business Type : MANUFACTURER & EXPORTER

Products Details : CIRCLE CUTTING LINE, ZIG-ZAG FEEDER, SLITTING LINE, MOTORIZED DECOILER (SINGLE/TWIN), NC SERVO FEEDER, MECHANIZED STRAIGHTENER
 Stall No. : **Stall No. 10,11 / Hall No. 2**

Company Name : **PRITAM INTERNATIONAL**

Address : 1/10 , Tilak Nagar
 City : DELHI

Contact Person : RAHUL KHERA
 Designation : Owner
 Cell No. : 9810267965

Email : rahulkhera@pritaminternational.com
 Website : www.pritaminternational.com

Brand Name : PRITAM
 Business Type : MANUFACTURE
 Products Details : COOKWARE , ALL KITCHENWERE. ITEMS

Stall No. : **Stall 86 / Hall 1**

Company Name : **PARSOTTAM INDUSTRIES**

Address : 6, Bhaktinagar Station Plot
 City : Rajkot 360 002

Contact Person : Pankaj Pipalia
 Designation : Managing Partner
 Telephone No. : 2812461220
 Fax No. : 2812461220
 Cell No. : 9825203451

Email : vimal900@yahoo.com
 Website : www.vimal90.com
 Brand Name : VIMAL-90
 Business Type : Manufacturing

Products Details : Gas lighters. Chilly cutters. knives. kichen press. Sevsancha. Onion and veg cutters. cutley sets. Puran machine

Stall No. : **Hall 1 / Stall 45**

Company Name : **QUALITY FOILS (INDIA) PVT LTD**

Address : 3, INDUSTRIAL DEVELOPMENT COLONY

City : HISAR
 Contact Person : MR. TEJASVI BHARGAVA

Designation : DIRECTOR
 Telephone No. : +91 1662 220327
 Fax No. : + 91 1662 220330

Email : CONTACTUS@QUALITYFOILS.COM
 Website : WWW.QUALITYFOILS.COM, WWW.QUALITYGROUPIN

Business Type : MANUFACTURERS & EXPORTERS

Products Details : STAINLESS STEEL COILS/STRIPS, SEAMLESS & WELDED STAINLESS STEEL TUBES & PIPES, FLEXIBLE HOSE & ASSEMBLIES

Stall No. : **HALL NO. 3 / BOOTH NO. 53**

Company Name : **R.K. STAINLESS**
 Address : 12-B, RAGHUNAYAKULU STREET,

City : CHENNAI
 Contact Person : PUKHRAJ R JAIN

Designation : Propirter
 Telephone No. : 044-25354748

Cell No. : 9840038345
 Email : rkamarjyoti@gmail.com
 Website : www.rkamarjyoti.com

Brand Name : AMARJYOTI
 Business Type : MFRS

Products Details : KITCHENWARE & HOTELWARE
 Stall No. : **Stall No. 4 / Hall 1**

Company Name : **RAJEN ENTERPRISES**

Address : PLOT NO G- 2332/B, ALMIGHTY GATE NO-2, ROAD NO D4 B/H KIRLOSKAR OIL ENGINES,

City : RAJKOT
 Contact Person : ASHVIN BHAI

Designation : Owner
 Cell No. : 9825079620/ 9727640750
 Email : ashvinbhodi@gmail.com

Brand Name : Rydhm
 Business Type : Manufacture
 Products Details : hand Mixcy , Fruit Mixer & All kitchenwere. Items

Stall No. : **Hall No. 1 / Stall no. 47**

Company Name : **RAJKOT KITCHENWARE MANUFACTURE ASSOCIATION**

Address : Jay Krishna Ind. Estate, Plot No.18,Nh.8b,Shapar(Veraval)

City : RAJKOT-360002
 Telephone No. : 02827-252441

Company Name : **RAJPUTANA STAINLESS LTD**

Address : 213, MADHVAS, HALOL-KALOL ROAD, Ta: KALOL, DIST. PANCHMAHAL

City : VADODARA
 Contact Person : Shankar Mehta

Designation : Owner
 Telephone No. : 0265-3014817
 Fax No. : 0265-2422321
 Cell No. : 9825027823

Email : mail@rajputanastainless.com
 Website : www.rajputanastainless.com
 Brand Name : RAJPUTANA STAINLESS

Business Type : MANUFACTURERS & SUPPLIERS

Products Details : Stainless Steel Wire Rods, Square Bar, Round Bars, Hex Bar, Forged Ingots, Flat Bar, Billets, Angles

Stall No. : **Hall No. 3 / Booth No. 28**

Company Name : **SHREE RAMDEV METAL MART**

Address : Bldg. No.60, 1st Floor, 1st Carpenter Street, Off. Nanubhai Desai Road, Mumbai-400004.

City : MUMBAI
 Contact Person : Mr. Abhishek Purohit

Designation : Managing Partner
 Telephone No. : 91-022-66159028
 Fax No. : 91-022-23891817
 Cell No. : 91-09820223350

Email : abhishek@ramdev.org , info@ramdev.org
 Website : www.shreeramdevmetalmart.com

Brand Name : SRMM
 Business Type : IMPORTER, MANUFACTURER & PROCESSOR OF SS RAW MATERIAL

Products Details : SS COILS/SHEETS, CIRCLES, NO.4.MIRROR,HAIRLINE & COLOUR SHEETS

Stall No. : **Hall 3 / Stall 1**

Company Name : **RAMDEV METAL ART**
Address : 1 Rajaram Estate Greivity Wathc, Chakudia Mahdev Road, Rakhial

City : AHMEDABAD (GUJRAT)-380023

Contact Person : Malji bhavi V. Patel, Ganesh V. Patel

Designation : PROPRIETORS
Telephon No. : 079-30417780, 22727780
Cell No. : 9426344780, 9825149780, 9428114127

Email : mvnpatel@gmail.com, ganeshramdevimpex@gmail.com, info@stainlesssteelramdev.com

Website : www.ramdevmetalart.com, www.stainlesssteelramdev.com

Business Type : MANUFACTURERS
Products Details : RAW MATERIAL, SHEET, CIRCLE

Stall No. : **Hall No. 2, / Booth 80**

Company Name : **RAMDEV STAINLESS STRIPS PVT. LTD.**
Address : B-67(B-1& B-2) M.I.A 2nd PHASE BASNI, JODHPUR-342005 (RAJASTHAN)

City : JODHPUR

Contact Person : SANWARMAL AGARWAL AND RAGHAV AGARWAL

Designation : DIRECTORS
Telephon No. : 0291-2740017, 0291-2632731
Fax No. : 0291-2741327
Cell No. : 098290-21009, 095711-27000

Email : sanwarmalagarwal11@gmail.com

Website : www.jupitersteels.com

Brand Name : SUNSHINE, JUPITER AND RAMDEV

Business Type : MANUFACTURERS
Products Details : STAINLESS STEEL UTENSILS, CIRCLES AND SHEETS

Stall No. : **STALL NO.25 AND BOOTH NO.4**

Company Name : **RAMSON INDUSTRIES**
Address : 111-D, GOVT INDUSTRIAL ESTATE CHARKOP KANDIVALI (WEST)

City : MUMBAI

Contact Person : PARESH SHAH
Designation : Director
Telephon No. : 022-28682618
Cell No. : 9820186233
Email : ramsonind@gmail.com
Website : www.ramsonind.com

Brand Name : RAMSON
Business Type : MFRS
Products Details : SS UTENSILS, CUTLERY & HOUSEHOLD ITEM

Stall No. : **Stall 6 / Hall 1**

Company Name : **RATAN ENTERPRISES**
Address : 25, Raghunayakulu Street
City : CHENNAI (T.N.)-600003

Contact Person : Ashok Jain, Ansul Jain
Position / Designation : Owner
Telephon No. : 044-42371194, 23468153, 25352581

Cell No. : 9840127741, 9884443682
Email : navkarindia9@gmail.com, www.srinavkar.com

Website : www.srinavkar.com
Brand Name : SRI NAVKAR
Business Type : MANUFACTURERS
Products Details : Stainless Steel Houseware Products

Stall No. : **HALL NO. 1 / BOOTH NO. 61**

Company Name : **RATHI STEEL & POWER LTD.**
Address : 24/1A, Mohan Co-Operative Industrial Estates, Mathura Road

City : NEW DELHI-110044

Contact Person : Mr. Udit
Telephon No. : 011-40512426-28
Fax No. : 011-26991061
Email : uditrathi04@gmail.com, www.rathisteel.co.in

Brand Name : RATHI
Business Type : MANUFACTURERS
Products Details : TMT BARS, WIRE, RODS

Stall No. : **HALL NO. 3 / STALL NO. 18**

Company Name : **RATHORE IMPEX**
Address : NO 6/11 KRISHANAPA AGRAHARAM STREET, KONDITHOPE

City : CHENNAI

Contact Person : JIGNESH SHAH
Designation : CEO
Telephon No. : 00 91 44 23463227
Fax No. : 00 91 44 23468342
Cell No. : 00 91 9841787961

Email : RATHOREIMPEXKVJ@GMAIL.COM

Website : WWW.RATHOREIMPEX.COM

Brand Name : RATHORE
Business Type : MANUFACTURER AND EXPORTER OF STAINLESS UTENSILS

Products Details : STAINLESS STEEL HOTPOTS

Stall No. : **HALL 1 / BOOTH NO. 42**

Company Name : **RATNA HOME RPRODUCTS PVT. LTD.**
Address : 63, BADA MANDIR COMPOUND, PANJARAPOLE ROAD,

City : MUMBAI - 400 002.

Contact Person : MR.DHIRAJ GALA
Designation : MANAGING DIRECTOR
Telephon No. : 022-2242 4100/ 3240 8081
Cell No. : 098211 39142
Email : support@ratnahomeproducts.in

Website : www.ratnahomeproducts.in

Brand Name : RATNA ® / KUKU ® / GULU ®
Business Type : MANUFACTURERS / TRADER
Products Details : KITCHENWARE * DINNERWARE * TABLEWARE

Stall No. : **HALL 1 / BOOTH 13**

Company Name : **RATNAMANI METAL & TUBE LTD**
Address : 17, Rajmugat Society, Naranpura Cross, Ankur Road

City : AHMEDABAD-380013

Contact Person : Prakash Sanghvi
Designation : Director
Telephon No. : 079-27415501
Cell No. : 9825009426

Email : info@ratnamani.com, ps@ratnamani.com, export@ratnamani.com, ss@ratnamani.com, www.ratnamani.com

Brand Name : RATNAMANI
Business Type : MANUFACTURERS
Products Details : STAINLESS STEEL WIRE & TUBE, PIPE

Stall No. : **Hall No. 3 / Booth No. 13**

Company Name : **Rataveer Stainless Products Pvt.Ltd.**
Address : E-77, G.I.D.C. Manjusar (Savli Road),

City : Dist : Vadodara : 391 775, Gujarat

Contact Person : Mr.Vijay R. Sanghvi // Mr.Devang R. Shah
Designation : Managing Director // DGM - Marketing
Telephon No. : +91 2667 264594 / 264595 / 264596

Company Name : **RATNAMANI METAL & TUBE LTD**
Address : 17, Rajmugat Society, Naranpura Cross, Ankur Road

City : AHMEDABAD-380013

Contact Person : Prakash Sanghvi
Designation : Director
Telephon No. : 079-27415501
Cell No. : 9825009426

Email : info@ratnamani.com, ps@ratnamani.com, export@ratnamani.com, ss@ratnamani.com, www.ratnamani.com

Brand Name : RATNAMANI
Business Type : MANUFACTURERS
Products Details : STAINLESS STEEL WIRE & TUBE, PIPE

Stall No. : **Hall No. 3 / Booth No. 13**

Company Name : **Rataveer Stainless Products Pvt.Ltd.**
Address : E-77, G.I.D.C. Manjusar (Savli Road),

City : Dist : Vadodara : 391 775, Gujarat

Contact Person : Mr.Vijay R. Sanghvi // Mr.Devang R. Shah
Designation : Managing Director // DGM - Marketing
Telephon No. : +91 2667 264594 / 264595 / 264596

Fax No. : +91 2667 264593
Cell No. : +91 98250 27345 // +91 99252 47405

Email : marketing@ratnaveer.com / devangs@ratnaveer.com, www.ratnaveer.com

Website : www.ratnaveer.com

Brand Name : Ferrum
Business Type : Manufacturer // Exporter
Products Details : No. 8 Mirror Finish / Hair Line Finish / No. 4 Satin / Mate Finish

Stall No. : **Hall No. 3 / Stall No. : 26**

Company Name : **RAVI - RAJ ANODISERS**
Address : C-Block, 2/21, Pimpri

City : PUNE (Maharashtra)-411017

Contact Person : RAVI YAWALKAR
Designation : Owner
Cell No. : 9823208347, 9953362812
Email : ravi@ravirajanodisers.com, www.ravirajanodisers.com

Brand Name : Anodisers
Business Type : Manufacture
Products Details : Manufacturer & service providers in the domain of etching nameplates on different metals like Anodised Nameplates, Etched Nameplates and Brass Etched Nameplates along with Anodized Services.

Stall No. : **Hall No. 3 / Booth No. 84**

Company Name : **REAL STEEL KRAFTS**
Address : 1, RATAN HALDER LANE, LILUAH, HOWRAH

City : KOLKATA

Contact Person : RAJ SHARMA
Designation : PARTNER
Cell No. : 8420965015, 9831067008
Email : realsteelkrafts@gmail.com, www.realsteelkrafts.com

Brand Name : REAL
Business Type : MFRS
Products Details : KITCHEN SINKS & STAND

Stall No. : **STALL 48 / HALL 1**

Company Name : **RIDDHI SIDDHI IMPEX**
Address : 516, MAULANA AZAD ROAD, NEAR GULALWADI CIRCLE

City : MUMBAI

Contact Person : MR. SURESH KANUNGO
Designation : PARTNER
Telephon No. : 2266393666
Fax No. : 2223872005
Cell No. : 9820333450

Email : sureshkanungors@gmail.com, www.riddhisiddhiimpex.in

Business Type : IMPORTER AND TRADER
Products Details : STAINLESS STEEL STRIPS COILS

Stall No. : **BOOT NO - 35, HALL 3**

Company Name : **RIDDHI METAL / TARUN ENTERPRISES**
Address : S/6, Pushpam Ind. Estate, B.P. Cross Road No.3, Bhaji Gali, Near Dhanlaxmi Electric, (E)

City : BHAYANDER (E) (MHRSTR)-401105

Contact Person : TALAKSHI BHAI
Designation : PROPRIETORS
Telephon No. : 022-2804237, 28149221
Cell No. : 9820132632
Email : kevaltgosar@gmail.com, paanjosteel@gmail.com, www.riddhimetals.com

Brand Name : PAANJO
Business Type : MANUFACTURERS & TRADERS
Products Details : S.S. UTENSILS

Stall No. : **Hall No. 1, / Booth 37**

Company Name : **RIMJHIM ISPAT LTD**
 Address : 123/260, Fazalganj
 City : KANPUT (U.P.)-208012
 Contact Person : Arvinder Chadha
 Designation : Head-Export Business
 Telephone No. : 0512-2240980-5
 Fax No. : 0512-2295035
 Cell No. : 9826030197, 9893690197
 Email : ac@rimjihimispac.com, mail@rimjihimispac.com, export@rimjihimispac.com
 Website : www.rimjihimispac.com
 Brand Name : RIMJHIM
 Business Type : MANUFACTURERS & SUPPLIERS
 Products Details : Integrated stainless steel plant producing stainless steel billets/blooms/slabs, Wire rods, Bright bars, Wires and HRAP coils and CR coils
 Stall No. : **Hall No. 3 / Booth 5**

Company Name : **ROHIT FERRO-TECH LIMITED**
 Address : 35, Chittaranjan Avenue, (4th Floor)
 City : KOLKATA-700012
 Contact Person : Mr. Suresh Kumar Patni,
 Designation : Chairman
 Telephone No. : 033 2211 9805/9806
 Fax No. : 033 4016 8107/8189
 Cell No. : 9831005287
 Email : chairman@rohitferrotech.com, enquiry@rohitferrotech.com
 Website : www.rohitferrotech.com
 Brand Name : ROHIT, SKP
 Business Type : MANUFACTURERS
 Products Details : Austenitic, Ferritic, Martenitic, Austenitic-Ferritic grades, Stainless Steel with special grades of Precipitation hardening, Cold heading and Electrode quality etc.
 Stall No. : **Hall No. 3, / BOOTH NO. 4**

Company Name : **ROHIT POLISHERS**
 Address : Rohit Main Road, Near Radhakrishna Temple, Dahanu, Dist. Thane - 401601.
 COUNTRY : India
 City : Dahanu
 Contact Person : Mr. SAMKIT GANDHI
 Position / Designation : Head - Business Development
 Telephone No. : 224603, 224604
 Fax No. : --
 Cell No. : 09730420999, 09890220999
 Email : sales@rohitpolishers.com
 Website : www.rohitpolishers.com
 Brand Name : ROHIT & DAHANU
 Business Type : MANUFACTURERS / EXPORTER
 Products Details : Abrasive Belt Grinding / Polishing Machine for SS Round / Square Tube, Rod & SPM's.
 Stall No. : **HALL NO. 2 / BOOTH NO. 38**

Company Name : **ROLL TECH ENGINEERING PVT LTD**
 Address : B-31, C1-501, G.I.D.C., Industrial Estate, Odhav,
 City : AHMEDABAD (GUJ)
 Contact Person : Mr. S. B. Chaumal, Mr. Somesh S. Chaumal
 Designation : PROPRIETORS
 Telephone No. : 079-2870179 (W)
 Cell No. : 9879504470, 9825005054
 Email : sumesh27@yahoo.co.in, info@rolltechindia.com, www.rolltechindia.com
 Website : www.rolltechindia.com
 Brand Name : ROLLTECH
 Business Type : Manufacturers
 Products Details : Machinery : Reduction Gear

Box, Re-Heating Furnace, Ejector Machine, Rolls Assembly, Pusher Machine, High Speed Flywheel
 Stall No. : **Hall No. 2, / Booth 27**
 Company Name : **ROOPS INDUSTRIES**
 Address : DAHANLAXMI INDUSTRIAL ESTATE, GALA NO-2, NAVGHAR, OPP. POOJA HOTEL, VASAI-EAST,
 City : THANE
 Contact Person : TUSHAR MARU
 Designation : Propirter
 Telephone No. : 0250-2391019
 Cell No. : 9869071663, 9769067011
 Email : info@roopsindustries.com, www.roopsindustries@yahoo.co.in
 Website : roopsindustries.com
 Brand Name : ROOPS
 Business Type : MFRS
 Products Details : KITCHEN TOOLS & KITCHEN ITEMS
 Stall No. : **Stall No. 9 / HALL 1**

Company Name : **ROYAL INDUSTRIES**
 Address : C-56/2, BASEMENT, WAZIRPUR INDUSTRIAL AREA, NEW DELHI-110052
 City : NEW DELHI
 Contact Person : MANISH GUPTA
 Designation : PARTNER
 Telephone No. : 011-27377302, 42475525
 Fax No. : -
 Cell No. : 09811370500, 08130230230
 Email : royalindustries_cutlery@yahoo.com
 Website : www.royalcutlery.in
 Brand Name : ROYAL & ROYAL GOLD
 Business Type : MANUFACTURING OF STAINLESS STEEL CUTLERY
 Products Details : CUTLERY & DUST BIN HOTEL WARES & HOUSE HOLD ITEMS
 Stall No. : **HALL 1 / STALL 22**

Company Name : **S.L. Industries**
 Address : F-57, Mayapuri Industrial Area, Phase-2,
 City : New Delhi - 110064
 Contact Person : K.K. Pahuja
 Designation : Proprietor
 Telephone No. : 011-41845134, 41845554
 Cell No. : 9811144169
 Email : elegantcutlery@gmail.com
 Brand Name : Elegante
 Business Type : Manufacturing
 Products Details : Cutlery & Kitchen Tools
 Stall No. : **Hall No.1- Stall No. 88**

Company Name : **SACHETA METALS LTD**
 Address : SAKSERIA INDL ESTATE, CHINCHOLI, S.V.ROAD, MALAD(WEST), MU-64
 City : MUMBAI
 Contact Person : MR. SATISH K SHAH
 Designation : MGG DIRECTOR
 Telephone No. : 0091-22-2872 5948
 Fax No. : 0091-22-2873 7934
 Cell No. : 9820137137
 Email : sacheta@sacheta.com/sacheta metalsltd@gmail.com
 Website : www.sacheta.com
 Brand Name : SACHETA
 Business Type : MANUFACTURER EXPORTER
 Products Details : ALUMINIUM HOUSEHOLD UTENSILS, ALU. HOUSE FOIL, SHEET, COIL
 Stall No. : **HALL NO.1, STALL NO. 11**

Company Name : **SAGA STEEL**
 Address : C/O NARESH CHANDRA MITTAL SHAU STREET, MANDI CHOWK,
 City : MORADABAD
 Contact Person : SOURABH MITTAL
 Designation : owner
 Telephone No. : 0591-2472201
 Cell No. : 9837063193
 Email : sagasteels@gmail.com
 Website : www.sagasteels.com
 Brand Name : SAGA
 Business Type : Mfrs & Supplier
 Products Details : Copper Utensils
 Stall No. : **STALL 46 / HALL 1**

Company Name : **STEEL AUTHORITY OF INDIA**
 Address : Salem Steel Plant, Salem
 City : Salem (Tamil Nadu)
 Contact Person : Mr. Raman
 Designation : Excutive Director
 Telephone No. : 0427-2383080, 2382803
 Email : ed@sailssp.in, sspnkt@sancharnet.in
 Website : www.sail.co.in/
 Brand Name : SAIL
 Business Type : Manufacturers
 Products Details : Bars and rods, Billets, blooms, Forgings, Other stainless steel products, Slabs, plates, sheets / coils (HR)
 Stall No. : **Hall 3 / Booth 22**

Company Name : **SALEM STAINLESS STEEL SUPPLIERS PVT. LTD.**
 Address : #33, Lawyer Chinnathambi Street Kondithope
 City : CHENNAI (T.N.)-600079
 Contact Person : Mr. Sripal S. Jain, Mr. Abhishek Jain
 Designation : PROPRIETORS
 Telephone No. : 044-23463000, 3051, 3053, 3054, 3055
 Cell No. : 0944409353, 09655995555, 9444964178
 Email : info@ssssgroup.com, sripal1972@gmail.com, abhishek@ssssgroup.com
 Website : www.ssssgroup.com
 Brand Name : SALEM
 Business Type : SUPPLIER, TRADING
 Products Details : supplier of SS Metal Pipe Accessories, SS Metal Rings & Clothing, SS Metal Bars, SS Metal Sheets, SS Metal Wire Supports etc.
 Stall No. : **Hall No. 3, / Booth 21**

Company Name : **SALAM**
 Address : No. 97 2nd Stage Ind. Suburb Yashwantpur Tonku Road,
 City : Banglour
 Contact Person : SURESH BAGHRECHA
 Designation : Owner
 Cell No. : 9844111037
 Email : sureshbagrech@yahoo.com
 Brand Name : Suman
 Business Type : Manufacture / Raw Material
 Products Details : Houseware, Vactue Product
 Stall No. : **Hall No.1 / Booth No. 83**

Company Name : **SANDEEP INDUSTRIES**
 Address : 27/A -1st Heavy Industrial Area
 City : JODHPUR (RAJ)-342003
 Contact Person : Sandeep Kanungo
 Designation : Owner
 Telephone No. : 0291-2744705, 2741705, 2741411
 Cell No. : 9829021704
 Email : sandeep@steelglow.com
 Website : www.steelglow.com
 Brand Name : Steel Glow

Business Type : Manufacture.
 Products Details : Tube, Pipe, Section
 Stall No. : **Hall No. 3 / Booth No. 38**

Company Name : **SANTOSH STEEL INDUSTRIES**
 Address : SURVEY NO. 357/3 & 357/2/1; behind DADRA GARDEN
 City : DADRA
 Contact Person : ATUL GOYAL
 Designation : DIRECTOR
 Telephone No. : 0260-3292698
 Fax No. : 0260-2669146
 Cell No. : 9687603059
 Email : atul@santoshsteels.com
 Website : www.santoshsteels.com
 Brand Name : SANTOSH
 Business Type : MANUFACTURER
 Products Details : STAINLESS STEEL PIPES & TUBES
 Stall No. : **HALL 3 / STALL 30**

Company Name : **SANVIJAY ROLLING & ENGINEERING LTD**
 Address : 9, IMAMBADA ROAD, OPP. BAJAJ STEEL
 City : NAGPUR-440018
 Contact Person : Mr. Saurabh Agarwal
 Telephone No. : 0712-272 9130 -136
 Fax No. : 0712 272 0716, 272 3799
 Cell No. : 9822221505
 Email : steel@sanvijay.com, store@sanvijay.com
 Website : www.sanvijay.com
 Brand Name : SANVIJAY
 Business Type : Manufacturers
 Products Details : Angles, Channels, Broad Flange Beams, Bems/Joists, Flats, Squares, Rounds,
 Stall No. : **Hall No. 3, / Booth 59**

Company Name : **SARIKA STAINLESS STEEL INDUSTRY**
 Address : 86, DSIDC COMPLEX, WAZIRPUR INDUSTRIAL AREA
 City : DELHI - 110052
 Contact Person : MR. L. N. AGGARWAL & TARUN AGGARWAL
 Designation : PROP
 Telephone No. : +91-11-27371497, 27372859
 Fax No. : +91-11-27375528
 Cell No. : +91-9810047991, 9810146460
 Email : info@sarikaindia.com; sssi@vsnl.com
 Website : http://www.sarikaindia.com
 Brand Name : SARIKA
 Business Type : MANUFACTURER EXPORTER
 Products Details : STAINLESS STEEL UTENSILS & HOTELWARE PRODUCTS
 Stall No. : **STALL NO 31 / HALL NO 1**

Company Name : **SATYAPUR STEEL**
 Address : 119/121, C.P. TANK ROAD, NEAR MADHAV BAUG, MUMBAI
 City : MUMBAI
 Contact Person : SHANTILAL SHAH
 Designation : owner
 Cell No. : 9223511408/ 9820037204
 Email : satyapuri@hotmail.com
 Brand Name : SATYAPUR
 Business Type : Manufacture.
 Products Details : sheet , patta, Raw material
 Stall No. : **Hall No. 3 / Booth No. 47**

Company Name : **SAURASHTRA ENGINEERING**
 Address : 21/1, G V M M, Odhav Road, Odhav Road
 City : AHMEDABAD-382410
 Contact Person : KANTI BHAI
 Position / Designation : OWNER
 Cell No. : 9825109659/8046069029
 Email : solid.saurashtra@gmail.com
 Business Type : MANUFACTURERS

Products Details : MACHINERY
 Stall No. : **STALL NO 28 / HALL NO 2**

Company Name : **Sawan Steel**
 Address : G-10/A, Swastik Industrial Estate, Mira - Bhyander Road, Near Railway Crossing, Bhyander East, Thane - 401105, Maharashtra , India.

City : Mumbai
 Contact Person : Ramesh Nagda
 Designation : Director
 Telephone No. : 022-28181852
 Cell No. : 8080666607
 Email : info@sawansteel.com
 Website : www.sawansteel.com
 Brand Name : Sawan | GoodLife | Platinum
 Business Type : Trader
 Products Details : Designer Canister, Lunch Accessories, Kitchen Utility, Storage Canister, Liquid Vessels
 Stall No. : **Hall - 1, Stall -54.**

Company Name : **SWATI METAL**
 Address : PINNACLE CORPORATION, GOLDEN CHOKDI, BEHIND KRISHNA PARK, NEAR PRASHANT FOUNDRY , VAVDI.
 City : RAJKOT-380002
 Contact Person : Mr. MUKUNDSINH JHALA
 Designation : PROPRIETORS
 Telephone No. : 0281-2388673, 2362686
 Cell No. : 9825076868
 Email : info@swatimetal.com, Mukundsinh.jhala@yahoo.com
 Website : www.swatimetal.com
 Brand Name : SWATI
 Business Type : MANUFACTURERS
 Products Details : STAINLESS STEEL UTENSILS AND HOUSEWARE PRODUCTS
 Stall No. : **Hall No. 1, / Booth 43**

Company Name : **Saya Paper Print Pvt. Ltd.**
 Address : Nr. Khodiyar mata mandir,sharkhej-sanad road,santipura village santipura, sharkhej- 59 ahmedabad gujarat india .
 City :
 Contact Person : sabir kabli
 Designation : Director
 Telephone No. : 9825040377,
 Cell No. : 7931907770
 Email : chirag.vishnagar@gmail.com / rafikkabli@yahoo.com
 Website : www.sayaprint.com
 Brand Name : Saya Etching
 Business Type : manufacturers.
 Products Details : designer Stainless Steel sheet and press plate,moulds.
 Stall No. : **HALL NO. 3 / BOOTH 29**

Company Name : **SCREENLAND PRINT INDIA PVT LTD**
 Address : NO- 51, KRISHNAAPPA, AGRAHARA M STREET, KONDITHOPE,
 City : CHENNAI
 Contact Person : RAJIV BHAI
 Designation : Director
 Telephone No. : 044-23465425
 Cell No. : 9884022026
 Email : info@screenland.in
 Website : www.screenland.in
 Brand Name : SLB
 Business Type : Mfrs
 Products Details : STICKER & LABEL
 Stall No. : **STALL 56 / HALL 1**

Company Name : **SEVEN SEAS CORPORATION**
 Address : 111-D, GOVT INDUSTRIAL ESTATE CHARKOP KANDIVALI (WEST)
 City :
 Contact Person :
 Designation :
 Telephone No. :
 Cell No. :
 Email :
 Website :
 Brand Name :
 Business Type :
 Products Details :
 Stall No. :

City : MUMBAI
 Contact Person : PARESH SHAH
 Designation : Director
 Telephone No. : 022-28682618
 Cell No. : 9820186233
 Email : ramsonind@gmail.com
 Website : www.sevenseascorporation.com

Brand Name : SEVEN SEAS
 Business Type : IMPORTRS
 Products Details : HOUSEHOLD ITEMS
 Stall No. : **STALL NO. 6 / HALL 1**

Company Name : **SHAH ALLOYS LTD**
 Address : 5/1, Shreeji House, Behind M.J Library, Ashram Road.
 City : AHMEDABAD (GUJRAT)
 Contact Person : Rajender V Shah
 Designation : Owner
 Telephone No. : 02764 - 661100, 286525, 286545
 Cell No. : 9099023093
 Email : info@shahfoils.com
 Website : www.shahalloys.com
 Brand Name : SHAH ALLOYS
 Business Type : MANUFACTURERS
 Products Details : Flats, Other stainless steel products, Sheets / coils (CR), Slabs, plates, sheets / coils (HR) Wire
 Stall No. : **Hall No. 3 / Booth No. 23**

Company Name : **SHAH FOILS PVT. LTD.**
 Address : Reg. Off.: 1820/1 Santej-Khatraj Road, Near Rajnagar Bus Stop, Santej, Taluka: Kalol. (Guj.) Dist. GANDHINAGAR (GUJ)-382725
 Contact Person : Dinesh Shah/ Kartik Shah
 Designation : PROPRIETORS
 Telephone No. : 02764-320500, 286894, 286234
 Cell No. : 9820149989, 9376168794
 Email : info@shahfoils.com, krshah@shahfoils.com, shahfoils@hotmail.com
 Website : www.shahfoils.com
 Brand Name : SHAH FOILS
 Business Type : Manufacturers & Exporter
 Products Details : Stainless Steel Coil Roll Coil & Circle, Stainless Steel Cold Roll Coil & Circle
 Stall No. : **Hall No. 3, / Booth 24**

Company Name : **SHARMA MACHINE TOOLS**
 Address : CB-164, Ring Road Naraina, NEW DELHI-110028
 City :
 Contact Person : Mr. Neeraj Sharma, Mr. Prakash Sharma
 Designation : Owner
 Telephone No. : 011-25778063, 25778220
 Cell No. : 9811033616, 9811030284
 Email : smtparkash@rediffmail.com, info@smtparkash.net
 Website : www.smtparkash.com
 Brand Name : SMT
 Business Type : MANUFACTURERS & EXPORTER
 Products Details : Deep Drawing Double Action, Pressing Machine
 Stall No. : **Hall No. 2 / Booth no. 49**

Company Name : **PS RAJ STEELS PVT. LTD. / SHEELA STAINLESS PVT. LTD**
 Address : 1st Floor, Inside Nagori Gate, Opp. Jain Mandir
 City : HISAR-125001
 Contact Person : Mr. Deepak Kumar Gupta
 Designation : DIRECTOR
 Telephone No. : 01662-236791, 230373
 Cell No. : 9812583010, 9992555462
 Email : info@psrajsteels.com, purchase@psrajsteels.com, sales@psrajsteels.com

Website : www.psrjsteels.com,
http://sheelastainless.com/
Brand Name : PS RAJ/SHEEL STAINLESS
Business Type : MANUFACTURERS &
IMPORTERS
Products Details : Mfs of s.s. Tubes pipes, impts of
s.s. Sheets and coils
Stall No. : **HALL NO. 3 / BOOTH 57**

Company Name : **SHILPA STAINLESS PVT LTD**
Address : PLOT NO.62,VYSARPADI CO
OP INDUSTRIAL ESTATE
,ERUNKANCHERY HIGH
ROAD,VYSARPADI
CHENNAI 600 039
City : CHENNAI
Contact Person : ABOO BACKER /MANGAL
JAIN/NIKHIL JAIN
Designation : MANAGING
DIRECTOR/BUSINESS
DEVELOPMENT
MANAGER/BUSINESS
DEVELOPMENT MANAGER
Telephone No. : 044-43480200(10LINES)
Fax No. : 044-26430462
Cell No. : 9841033178 / 9840420221 /
9566033124
Email : aboobacker@praylady.com ,
mangal@praylady.com,nikhil@
praylady.com,connect@praylad
y.com
Website : www.praylady.in
Brand Name : PRAYLADY
Business Type : MANUFACTURERS AND
EXPORTER
Products Details : COOKINGWARE,KITCHENWAR
E,SERVINGWARE AND
TABLEWARE
Stall No. : **STALL 38 / HALL - 1**

Company Name : **SHINE GLOBAL HOUSEWARE LTD INE**
Address : #41, VAIDYANATH MUDALI
STREET, TONDIARPET,
CHENNAI
City : CHENNAI
Contact Person : SHANTILAL JAIN
Designation : Owner
Telephone No. : 044-43016017
Cell No. : 9841030255
Email : shinestainless@hotmail.com
Website : www.goldenlifestyle.co
Brand Name : SHINE GLOBAL, GOLDEN LIFE
STYLE
Business Type : Manufacturers
Products Details : Houseware Items, Kitchenware
Stall No. : **HALL 1 / BOOTH 50**

Company Name : **SHREE BALAJI METAL INDUSTRIES**
Address : PLOT NO. 22, GOLANI
INDUSTRIAL COMPLEX, WALIV
VASAI EAST PALGHAR
City : 401208
Contact Person : MUMBAI
Designation : RACHIT VORA
Telephone No. : DIRECTOR
Fax No. : 0250-3268699
Cell No. : 9619855564
Email : ninemetal@gmail.com ,
care@nanonine.in
Website : www.nanonine.in
Brand Name : NanoNine
Business Type : MANUFACTURER &
EXPORTER
Products Details : INSULATED STAINLESS
STEEL INNOVATIVE
KITCHENWARE PRODUCT
Booth No. : Stall 8 / Hall 1

Company Name : **SHREE PRITI ACE METALS PVT. LTD.**
Address : JK IND. COMPOUND GALA
NO. A/09, A/10,A/11 VIRAR
EAST HIGH WAY NEXT TO
SHANKAR BHAGAWAN
MANDIR INSIDE NOVELTY
HOTEL
City : MUMBAI
Contact Person : RAJESH/DEEP/NEEL
Designation : DIRECTOR
Cell No. : 9321128486/9322831750/9321
199979

Email : PRITIACE@GMAIL.COM
Website : WWW.PRITIACEMETALS.COM
Brand Name : PRITI
Business Type : MANUFACTURING/TRADING/J
OB WORK
Products Details : STAINLESS STEEL
COIL,CIRCLE,SLIT
Booth No. : Stall 40 / Hall 3

Company Name : **SHREE SAI AADINATH PLATER**
Address : GALA NO. 1/1-DUCT LANE,
KHINDI PADA, BHANDUP(W)
City : MUMBAI
Contact Person : BHAVESH K. NAGDA, Jinendra
Shahari
Designation : Propirter
Telephone No. : 022-5952607
Cell No. : 9820979760, 9320079760,
9321267818
Email : shreesaiadinathplater@gmail.c
om
Website : gurukrupacreation.com
Brand Name : GURUKRUPA
Business Type : mfts & trading
Products Details : Copper Plating, Desiner Gift
Articles
Stall No. : **STALL 36 / HALL 1**

Company Name : **Shree Shakti Enterprises Pvt' Ltd.**
Address : Plot No. 72, Sec- 57 Phase- IV,
HSIIDC ,KUNDLI ,
City : Sonapat Haryana
Contact Person : Mr. Rahul BAJAJ
Designation : Director
Telephone No. : 130-2219960/61/62
Fax No. : 0091-130-2219964
Cell No. : 9311830050
Email : rahul@pnbutensils.com,rahulba
jaj8609@yahoo.co.in
Website : www.pnbutensills.com
Brand Name : PNB
Business Type : MANUFACTURERS
Products Details : House ware/Kitchenware
/Tableware
Stall No. : **HALL 4 / STALL 14**

Company Name : **SHREEPAL OVERSEAS**
Address : B/4 KUSUMGHAR IND ESTATE
M I CABIN ROAD NEAR
GODDEV NAKA BUS STOP
BHAYENDER EAST
City : THANE - 401105
Contact Person : MR.NISHIT SHAH
Designation : PARTNER
Telephone No. : 022-28190522
Cell No. : 9833077060
Email : info@shreepal.com
Website : www.shreepal.com
Brand Name : shreepal
Business Type : manufacturer exporter
Products Details : hotelware kitchenware cutlery
Stall No. : **HALL 4/ STALL 26**

Company Name : **SHRI GOURAV INDUSTRIES**
Address : B/15, KASTURI IND. EST,

GODDEV PHATA ROAD,
PANCHAL, BHAYANDAR EAST,
City : THANE
Contact Person : INDER SANKHLA
Designation : Propirter
Telephone No. : 022-39315413
Cell No. : 9321027182
Email : shrigourav@gmail.com
Website : www.shrigourav.com
Brand Name : SHRI GOURAV
Business Type : MFRS
Products Details : HOUSEHOLD
Stall No. : **STALL 96 / HALL 1**

Company Name : **Shree Hari Industries**
Address : Survey No233, Plot 1/4, Opp
Rutvi Steel Veraval (Shapar)
Rajkot 360024
City : Rajkot
Contact Person : Akshat Goyal
Designation : Partner
Telephone No. : 912827293562
Fax No. : 912827253220
Email : info @shreehariind.com
Website : www.shreehariind.com
Brand Name : Shree Hari/ Feathers
Business Type : Manufacturing
Products Details : Aluminium Utensils, Tope,
Cooking pots
Stall No. : **Hall No.1 / Booth No. 44**

Company Name : **Shri Ram Utensils Industries Jodhpur**
Address : Plot no 1&2, Saboo Industrial
Estate, Tanawara Fatta,Salawars
Road,
City : Jodhpur
Contact Person : Rajesh Ojha
Designation : CEO
Telephone No. : 9352047580
Fax No. : CEO
Cell No. : 9828074607
Email : sru2012@rediffmail.com.
info@chikkumikku.com
Website : www.shrimangalmurti.com
www.chikkumikku.com

Brand Name : SHRIMANGALMURTI &
CHIKKUMIKKU
Business Type : Manufacturer
Products Details : Matki, Tope-khumcha parat
saucepan etc Box packing
items gift items
Stall No. : **HALL 1 / STALL 30**

Company Name : **SILVER MAGIC PRODUCTS**
Address : 34,6th Cross,K.PAgrahara
Magadi road
City : BENGALURU-560023
Contact Person : Mr. Punit Jain, Mr. Suresh Jain
Position / Designation : Owner
Cell No. : 9892842655, 9004481604
Email : sgambicaproducts@gmail.com,
info@silvermagic.in
Website : www.silvermagic.in,
www.silverglow.net

Brand Name : SILVER MAGIC
Business Type : MANUFACTURERS
Products Details : SILVER PLATE
Stall No. : **Hall no. 4 / Booth no. 20**

Company Name : **SMD SPOT WELD**
Address : 43, Vedachalam Street
Kanagachathiram GNT road
Madavaram-near Shell petrol
bunk
City : Chennai
Contact Person : C.N.Sivakumar
Position / Designation : CEO
Telephone No. : 91-44-65292104
Fax No. : NA
Cell No. : 91-9444025947/9381017899
Email : sales@smdspotweld.com/sugu
marspotweld@gmail.com
Website : www.smdspotweld.com

Brand Name : SMD/Sugumar & Naga
Business Type : Manufacturers
Products Details : Spot, projection, seam, Butt, Plasma Linear, Circular welding SPM, Laser welding, marking, cutting & stud welding machines

Stall No. : **hall-2 / stall no.9**

Company Name : **S.N.B. ENTERPRISES PVT. LTD.**
Address : C-16, SMA Industrial Areal, G.T. Karnal road, INDIA
City : DELHI
Contact Person : Shrinivas Bansal, Varun Bansal
Designation : Owner
Telephone No. : 011-27457024, 27693152, 47520000
Cell No. : 08930001590, 9811026596, 9871482288, 9811438824
Email : info@snbenterprises.com, snbansal@snbenterprises.com, www.snbenterprises.com
Website : www.snbenterprises.com
Brand Name : SNB
Business Type : MANUFACTURERS
Products Details : Raw material : Sheet, Coil, Houseware Product, Utensils, cutlery, kitchenware, thermoware,

Stall No. : **Hall No. 3/ Booth 48**

Company Name : **SNP HOMEWARE**
Address : Khasra No. 29/6, 1st Floor, Street No.-6, Master Mohalla, Libaspur
City : DELHI-110042
Contact Person : ROHIT JAIN
Designation : OWNER
Telephone No. : 011-27833145
Cell No. : 9811011174
Email : rohitjain@snphomeware.com, info@snphomeware.com, triconrj@gmail.com, www.snphomeware.com
Website : www.snphomeware.com
Brand Name : SNP
Business Type : MANUFACTURERS, TRADERS.
Products Details : SS Tableware, kitchenware and barware utensils

Stall No. : **Hall No. 4 / Booth No. 8**

Company Name : **SPINKS IMPEX**
Address : 88, Pace City-1, Sector- 37 Gurgaon, Haryana (India)-122001
City :
Contact Person : Mr. Murtaza Y. Merchant
Designation : HOD (Laser Machine Sales & Services)
Telephone No. : 0124-4770500, 528
Cell No. : 9999058835
Email : m.merchant@markolaser.com, info@markolaser.com, info@spinksworld.com
Website : www.markolaser.com, www.spinksworld.com
Brand Name : MARKOLASER
Business Type : Manufacturer
Products Details : Laser Marking Machine
Stall No. : **Hall 4 / Stall 8**

Company Name : **S R U STEELS LIMITED**
Address : 416-417-432, RAJENDRA JAINA TOWER-1, PLOT NO. 18 WAZIRPUR, SHOPPING COMPLEX,
City : AHMEDABAD-110052
Contact Person : Mr. RAMESH AGRAWAL, Mr. AMIT AGARWAL
Designation : Managing Directors
Telephone No. : 011- 27373622
Cell No. : 9820256311/ 9820946114
Email : srusteels@yahoo.in
Website : http://www.srusteels.in/
Brand Name : SRU

Business Type : TRADING
Products Details : STEEL PRODUCTS
Stall No. : **Hall No. 3, / Booth 34**

Company Name : **STEAMLINE INDUSTRIES LTD**
Address : 901 JAGDAMBA COMMERCIAL COMPLEX, KACHPADA, MALAD (w) MUMBAI-400064
City : MUMBAI
Contact Person : MR.DEVENDRA SHARMA
Designation : DIRECTOR
Telephone No. : 022-4099-9700
Fax No. : 2240999777
Cell No. : 09821449011
Email : devendra@steamlineind.com, pooja@steamlineind.com, www.steamlineind.com
Website : www.steamlineind.com
Brand Name : SIL
Business Type : Manufacturer & Exporter
Products Details : Stainless steel Seamless & Welded Pipes, Tubes & U-Tubes

Stall No. : **Hall 3 - Stall No.49**

Company Name : **STEEL AIIDS ENTERPRISES(Hastimal)**
Address : 2A, ALLARKHIA BLDG; Gr FLR; 9th KHETWADI LANE,
City : MUMBAI
Contact Person : SURESH BUKADIA
Designation : Owner
Cell No. : 9820011724
Email : steelaids@gmail.com
Business Type : MANUFACTURE
Products Details : RAW METERIALE
Stall No. : **STALL 41 / Hall 3**

Company Name : **STOVEKRAFT PVT. LTD.**
Address : No 81, Harohalli Industrial Area, Kanakapura Taluk, Ramanagara District - BANGLORE (KARNATAK)-560074
City :
Contact Person : Rajendra Gandhi
Designation : PROPRIETORS
Telephone No. : 080-2801 6222
Cell No. : 9844092981, 9845187321
Email : rajesh@stovekraft.com, info@stovekraft.com
Website : www.stovekraft.com
Brand Name : PIGEON
Business Type : Manufacturers
Products Details : kitchen appliances
Stall No. : **Hall No. 1 / Booth 12**

Company Name : **Subhiksh Steel Impex Pvt. Ltd.**
Address : Plot No 2, Kh.No 12/11, Amanpuri, Teacher Colony, Nangloi New Delhi-110041
City :
Contact Person : Vikesh Gupta
Designation : Director
Telephone No. : 011-25943215
Cell No. : 9310219573, 9891445785
Email : vikesh_airan@yahoo.co.in, http://subhikshsteelimpex.com
Website :
Brand Name : Airan, Chakmak, Monet
Business Type : MANUFACTURERS/IMPOTER/T RADER/WHOLESALE
Products Details : Stainless Steel Utensils, Aluminium Product, Non-Stick Cookware, House Hold Items

Stall No. : **Hall No 4, Stall No -11**

Company Name : **SUKHAR EXIM PVT. LTD.**
Address : 401 - 405 PAWAN PLAZA, SARDAR PATEL COLONY, OPP. LIFE CARE HOSPITAL, NARANPURA,
City : AHMEDABAD, GUJARAT - 380 013.
Contact Person : HARBHAJAN SINGH BANSAL
Designation : DIRECTOR

Telephone No. : 079-30080103
Fax No. : 079-30080104
Cell No. : 098253 16942
Email : info@sukharexim.com
Website : www.sukharexim.com
Brand Name : SUKHAR EXIM PVT. LTD.
Business Type : LOGISTICS AND FREIGHT FORWARDING
Products Details : LOGISTICS AND FREIGHT FORWARDING

Stall No. : **HALL NO. :- 2 / STALL NO.:- 76**

Company Name : **SUNCITY STRIPS & TUBES PRIVATE LIMITED**
Address : C/O SUNCITY GROUP OF INDUSTRIES, PLOT NUMBER SP-862 63.64 66 & 67 IV TH PHASE BORANADA INDUSTRIAL AREA, JODHPUR
City : JODHPUR
Contact Person : MAHAVEER AGARWAL
Designation : DIRECTOR
Telephone No. : 02931281479
Fax No. : 02931281478
Cell No. : 09829026533
Email : mahaveer@suncitytubes.com, suncity421@gmail.com
Website : www.suncitytubes.com
Brand Name : SUNCITY
Business Type : MANUFACTURER / EXPORTER / IMPORTER
Products Details : STAINLESS STEEL PIPE / TUBES / CIRCLES / SHEET & UTENSILS.

Stall No. : **HALL 3 / STALL 31**

Company Name : **Sun Glory Industry International Limited**
Address : RM1004, Peace world Plaza, No.362-366, Huanshi Dong Rd., Yuexiu District, Guangzhou, China.
City : guangzhou
Contact Person : Ms Elena
Designation : GENERAL MAGAGER
Telephone No. : 020-83649153
Fax No. : 020-83649153
Cell No. : 13922210559
Email : elena@sungloryind.com, sunglory@188.com, www.sungloryind.com
Website :
Brand Name : NO.2, Shiyu
Business Type : MANUFACTURERS
Products Details : Hydraulic pressing machine, polishing machine, sanding machine, trimming machine, washing line, hydraulic riveting machine, puching machine, Feeder, coating line, brazing machine, polishing wheel

Stall : **Hall 2 / Stall 47, 48**

Company Name : **Suresh Chandra Agarwal & Co.**
Address : 77/103 Mamu Bhanjha, Mittal Road
City : Aligarh
Contact Person : Abhinav Agarwal
Designation : G.M
Telephone No. : 02223892287, 05712510713, 05712510619
Fax No. : -
Cell No. : 9927021510, 9821096882, 9837091202
Email : cambaypolishing@gmail.com
Website : www.cambaypolish.com
Brand Name : "CAMBAY"
Business Type : Manufacturers
Products Details : Solid Polishing Compounds & Liquid Polishing Compounds

Stall No. : **HALL 3 / STALL 73**

Company Name : **Surya Prabha Enterprises**
 Address : C-39/1, Wazirpur Industrial Area, Delhi -110052
 City : Delhi
 Contact Person : Abhishek Singhal
 Designation : Proprietor
 Telephone No. : 9899763630, 9811042857
 Fax No. : 011 45769878
 Cell No. : 9899763630
 Email : abhishek63@gmail.com
 Website : www.prabhasteel.in
 Brand Name : Prabha
 Business Type : Manufacturers of S.S. Sheet, Circles & Utensils
 Stall No. : **Hall No-4, Stall No -4**

Company Name : **SURYODAY INDUSTRIES**
 Address : PLOT NO. 120, MEERA UDHYOG, AJI RING ROAD
 City : RAJKOT-360003
 Contact Person : ROHIT BHAI
 Designation : PROPRIETORS
 Telephone No. : 0281-2389258
 Cell No. : 9099923045
 Business Type : MANUFACTURERS
 Products Details : HOUSEWARE, KITCHENWARE PRODUCTS
 Stall No. : **Hall No. 1, / Booth 49**

Company Name : **SWASTIK LASER TECHNOLOGIES.**
 Address : 74, RAGHUVIR INDUSTRIAL ESTATE, OPP JAY CHEMICALS, ODHAV ROAD, ODHAV,
 City : AHMEDABAD - 382415
 Contact Person : MR. KETAN MALANI
 Designation : PARTNER
 Telephone No. : 079-22872376
 Fax No. : 079-22872651
 Cell No. : 9825506258
 Email : ketanmalani@hotmail.com
 Website : www.swastiklaser.com
 Brand Name : SWASTIK
 Business Type : MANUFACTURERS / EXPORTERS

Products Details : LASER MARKING MACHINE, CO2 LASER ENGRAVER AND CUTTER, DOT PIN MARKING MACHINE, LASER WELDING MACHINE, LASER CUTTING MACHINE
 Stall No. : **HALL NO - 2, STALL NO - 19**

Company Name : **SWASTIK TECHNOCAST LIMITED**
 Address : DELHI SAHARANPUR ROAD, VILLAGE DUNDUHERA, DISTRICT BAGHPAT, UTTAR PRADESH-201101
 City : MEERUT
 Contact Person : PANKAJ KUMAR JAIN / MAYANK JAIN
 Designation : DIRECTOR
 Telephone No. : 9811147449, 9811946024
 Fax No. : 01123212880
 Cell No. : 9811147449, 9811946024
 Email : INFO@SWASTIKTECHNOCAST.INFO
 Website : WWW.SWASTIKTECHNOCAST.INFO
 Business Type : MANUFACTURERS & EXPORTERS
 Products Details : INVESTMENT CASTING (FERROUS & NON-FERROUS)
 Stall No. : **Hall No. 3 / Booth no. 65**

Company Name : **TALL BOY INC.**
 Address : 56 A TRIBHUWAN ESTATE, KATWADA
 City : AHMEDABAD
 Contact Person : RAJESH BAFNA, MR. MANOJ
 Designation : Director
 Telephone No. : 079-22900031
 Cell No. : 9444055988, 9840790888
 Email : tallboyworld@gmail.com
 Website : www.tallboyworld.com
 Brand Name : TALL BOY
 Business Type : MFRS
 Products Details : HOUSEHOLD UTENSILS & CORPORATE GIFTS
 Stall No. : **Stall 19 / Hall 1**

Company Name : **Techflow Enterprises Pvt. Ltd.**
 Address : Block No. 803/B/1, Near Canal, Kubadthal village, Tal. Dascroi
 City : Ahmedabad - 382430
 Contact Person : Shrenik Parikh
 Designation : CEO - Component Division
 Telephone No. : 22872390
 Fax No. : 22971860
 Cell No. : 9909930270
 Email : shrenik.parikh@techflow.net
 Website : www.techflow.net
 Brand Name : Tuff
 Business Type : Manufacturers and Exporters
 Products Details : Blowers, Dust Collection Systems, Pneumatic conveying systems and its components and spares
 Stall No. : **Stall No. 12 - Hall No. 2**

Company Name : **THORSON INDUSTRIES**
 Address : 145, TEJENDRA ESTATE, NR. KOTAK MAHINDRA BANK, NR. SONI NI CHALI, ODHAV,
 City : AHMEDABAD, GUJARAT, INDIA
 Contact Person : MR. SIDDHARTH THORIA / MR. SAGAR THORIA
 Designation : PATNER
 Cell No. : M - +91 98244 64500 / M - +91 98244 51501
 Email : thorsonindia@gmail.com , thorson@thorson.in
 Website : 1. www.pipebendingmachines.in 2. www.thorson.in
 Brand Name : THORSON
 Business Type : MANUFACTURERS / EXPORTER
 Products Details : PIPE BENDING MACHINE, ELBOW BEDING MACHINE, ELECTRICAL INDUSTRIAL FURNACE, INDUSTRIAL OVEN, GAS FIRED FURNACE & OVEN ON LINE BLACK & BRIGHT ANNEALING FURNACE.
 Stall No. : **HALL NO. - 2, STALL NO. -6.**

Company Name : **TRANSFORMERS & RECTIFIERS (INDIA) LIMITED**
 Address : SARKHEJ BAWLA ROAD, CHANGODAR, TA: SANAND,
 City : AHMEDABAD
 Contact Person : MR. BIJOYEN DAS
 Designation : GENERAL MANAGER- INDUSTRIAL TRANSFORMER DIVISION
 Telephone No. : 02717-661661
 Fax No. : 02717-661716
 Cell No. : 8238080336
 Email : bijoyen.das@transformerindia.com
 Website : www.transformerindia.com
 Brand Name : TRANSFORMERS & RECTIFIERS

Business Type : MANUFACTURER OF FURNACE/POWER/DISTRIBUTION TRANSFORMERS
 Products Details : FURNACE/POWER/DISTRIBUTION/RECTIFIER TRANSFORMERS
 Stall No. : **HALL 2, Stall 65/66/67.**

Company Name : **TTK Prestige Limited**
 Address : 11th Floor, Brigade Towers, 135, Brigade Road, Bangalore-560025, India
 City : Bangalore
 Contact Person : Raj Kumar
 Designation : General Manager-Exports
 Telephone No. : +91-80-22217438
 Fax No. : +91-80-22277446
 Cell No. : +91-9845813757
 Email : raj@ttkprestige.com
 Website : www.prestigesmartkitchen.com
 Brand Name : Prestige & Mantra
 Business Type : Manufacture
 Products Details : Pressure Cooker, Non-stick Cookware, Multi Cooker, SS Cookware
 Stall No. : **Hall 4 / Booth No.16**

Company Name : **VAISHALI ENTERPRISE**
 Address : D-47, Sarvodaya Nagar, 1st Panjrapole Lane
 City : MUMBAI 400004
 Contact Person : Hiren Bhai/ Papat Bhai
 Designation : PROPRIETOR
 Telephone No. : 022-22427462
 Cell No. : 9930314327, 9324098203
 Email : hiren.khimsaria99@gmail.com
 Website : www.vaishalienterprise.in
 Brand Name : DAKSH
 Business Type : WHOLESALE
 Products Details : STAINLESS STEEL HANDICRAFT
 Stall No. : **Hall No. 1 / Booth No. 87**

Company Name : **Valbruna Stainless & Nickel Alloys India Pvt. Ltd.**
 Address : Mini Suit 3, Tower 3, Ground Floor, Equinox Bussiness Park, Off. Bkc , LBS Marg, Kuria (w), Mumbai - 400 070
 City : Mumbai
 Contact Person : Mr. Nadeem Hussain
 Designation : Area Commercial Manger
 Telephone No. : 022 - 4263 0201
 Fax No. : 022 - 6121 5163
 Cell No. : 9920 679 743
 Email : nadeem@valbrunaindia.com
 Website : www.valbruna-stainless-steel.com
 Brand Name : Reval®, Aeroval®, Bioval®, Marinox®, Magival®, Maxival®
 Business Type : Manufacturers
 Products Details : Nickel Alloys, Stainless Steel & Titanium Long Products Such as Round Bars, Square, Hexagons, Blooms & Billets, Ingots, Rebars, Flats, Angles, Wire & Wire Rod.
 Stall No. : **Hall No. 3 / Booth No. 76**

Company Name : **VALGRO INDIA LTD.**
 Address : VALGRO HOUSE, 2ND FLOOR, SHAILLY, NR. BHARAT PETROL PUMP, NH.8, VIRAT NAGAR
 City : AHMEDABAD
 Contact Person : ARVIND PATEL
 Designation : Owner
 Telephone No. : 079-22972603
 Email : cmd@valgro.co.in
 Website : www.brashingmachine.com
 Business Type : Manufacture.
 Products Details : Machinery

Stall No. : **Stall 44 / Hall 2**
 Company Name : **VARIA ENGINEERING WORKS PVT. LTD.**
 Address : 21, TITANIUM BUILDING, CORPORATE ROAD, Nr. PRAHLADNAGAR GARDEN, AHMEDABAD-380015.
 City : AHMEDABAD.
 Contact Person : Mr. HIMANSHU VARIA
 Designation : CMD
 Telephone No. : 079-40221400
 Fax No. : 079-40221410
 Cell No. : 9825005456
 Email : CMD@VARIAGROUPS.COM
 Website : WWW.VARIAGROUPS.COM
 Brand Name : VARIA
 Business Type : MANUFACTURERS OF STEEL PLANT & ROLLING MILL MACHINERY, S.S. COIL, ALU. FOIL, MS CRC COIL, ALU. HR COIL, ALU. CHECKER PLATE & ALU. CASE RAW.
 Products Details : ROLLING MACHINERY & STEEL PLANT/ SS COIL AND SHEET/ CRCA COIL & SHEET
 Stall No. : **STALL NO - 37 / BOOTH NO - 2**
 Company Name : **VARUN STAINLESS**
 Address : #208, MINT STREET, CHENNAI
 City : CHENNAI
 Contact Person : MAHESH KUMAR
 Designation : Director
 Telephone No. : 044-23465600
 Cell No. : 9841016325
 Email : varustainless@hotmail.com
 Website : premiumcookware.com
 Brand Name : PREMIUM COOKWARE
 Business Type : MFRS
 Products Details : COOKWARE
 Stall No. : **Stall 60 / Hall 1**
 Company Name : **VEDIK ISPAT PRIVATE LIMITED**
 Address : No. 1, Laxmi Nivas, Opposite Sanman Guest House, Model House Road, Basavangudi, BANGLORE (KARNATAK)-560004
 City : BANGLORE (KARNATAK)-560004
 Contact Person : Narendra Kumar Bhutra, Sharad Kumar Bhutara
 Designation : PROPRIETORS
 Telephone No. : 080-40909889
 Cell No. : 9342414333
 Email : vedikispat@gmail.com
 Business Type : MANUFACTURERS
 Products Details : Manufacturer of stainless steel billets, steel billets, knives for engineering industry, non alloy steel billets and industrial machinery billets.
 Stall No. : **Hall No. 3, / Booth 32**
 Company Name : **Venus Wires Industriess Pvt. Ltd.**
 Address : Unit No. 2002, 20th Floor, Tower No.3, Indiabulls Finance Center, Senapati Bapat Marg, Elphinstone Road, Mumbai - 400 013.
 City : Mumbai - 400 013.
 Contact Person : Mr. Pratik Sanghvi.
 Designation : DIRECTOR
 Telephone No. : 022- 30451000
 Cell No. : 9819800348
 Email : grsanghvi@venuswires.com
 Website : www.venuswires.com
 Brand Name : VENUS
 Business Type : MANUFACTURERS
 Products Details : Stainless Steel Wire Stainless Steel Bar Stainless Steel MIG Wire Stainless Steel TIG Wire

Stainless Steel Core Wire
 Stainless Steel Fine Wire
 Stainless Steel Welding Wire
 Stall No. : **HALL NO. 3 / BOOTH NO. 45, 46**
 Company Name : **VIVEK STEELCO PVT LTD. (A UNIT OF VICOR GROUP)**
 Address : A-201, MONDEAL SQUARE, NR. KARNAVATI CLUB, S.G.ROAD
 City : AHMEDABAD, GUJARAT
 Contact Person : MR.VIVEK AGARWAL
 Designation : MANAGING DIRECTOR
 Telephone No. : 40396010 , 40396011 , 26581088
 Fax No. : 26581088
 Cell No. : 9825049388
 Email : vivek@vicorgroup.com
 Website : www.vicorgroup.com
 Brand Name : VICOR
 Business Type : MANUFACTURERES & EXPORTER
 Products Details : Billets, Bright Bars, Flat Bars, Angles, Wire Rods, Ingots, Forged Bars of Stainless Steel, Alloys, Carbon & Mild steel
 Stall No. : **STALL NO.14, HALL NO.3**
 Company Name : **VIKAS METAL PRODUCTS**
 Address : A/9,DOSHI UDHYOG NAGAR,BEHIND UDIPI HOTEL,B.PROAD,
 City : BHAYANDER(EAST) , THANE-401 105,MAHARASTRA
 Contact Person : KANJI BHAI PATEL /MUKESH PATEL
 Designation : PROPRIETOR
 Telephone No. : 022-28041426
 Cell No. : 09819561188/09867313667
 Email : vikasunicorns@gmail.com
 Website : WWW.UNICORNS.NET.IN
 Brand Name : UNICORN'S
 Business Type : MANUFACTURES
 Products Details : TEA STRAINERS,SINK JALI,ATA CHALNI RINGS,FRUIT BASKET,SUPDI
 Stall No. : **HALL-4 / STALL NO-3**
 Company Name : **VIKAS INDUSTRIES**
 Address : D/8 Sujata Shopping Center, Navghar Road Bhayander (E) Thane
 City : MUMBAI - 401102
 Contact Person : Mr. Pahadsingh, Mr. Daragsingh Rajput
 Designation : PROPRIETORS
 Telephone No. : 022-81652156
 Cell No. : 9324080857, 9324565215, 9324954466
 Email : vikasIndustries.Rajput@yahoo.in
 Business Type : MANUFACTURERS & TRADERS
 Products Details : s.s.utensils, SS Top
 Stall No. : **Hall No. 1, / Booth 75**
 Company Name : **VIRAT ALLOYS (P) LTD.**
 Address : 127/3, CHHATRAL-KADI ROAD, NERA GOPAL WEIGH BRIDGE, AT-DHANOT, TA-KALOL, Dist. GANDHINAGAR (GUJ)382043
 City : GANDHINAGAR (GUJ)382043
 Contact Person : Mr. Hiten M Gada, Mr. Ronak Barot
 Designation : Partner
 Telephone No. : 02764-233121, 233120
 Cell No. : 9726155056 9324344672
 Email : viratalloys@yahoo.com, ronakbarot2000@yahoo.co.in
 Website : www.viratalloys.com
 Brand Name : VIRAT

Business Type : MANUFACTURERS
 Products Details : Mfr of Kitchenware, Utensils
 Stall No. : **Hall No. 1, / Booth 24**
 Company Name : **VISHWA STAINLESS PRIVATE LIMITED**
 Address : PLOT NO. 485, ROAD NO. 12, KATHWADA G.I.D.C., KATHWADA - 382430
 City : AHMEDABAD
 Contact Person : MR. HITESH SHAH
 Designation : DIRECTOR
 Telephone No. : 079-65243311
 Fax No. : 079-29703322
 Cell No. : 91-9824329432
 Email : info@vishwastainless.com
 Website : www.vishwastainless.com
 Brand Name : VSPL
 Business Type : MANUFACTURERS/EXPORTER
 Products Details : STAINLESS STEEL BRIGHT ROUND BAR, HEX BAR, SQUARE BAR, FLAT BAR, BLACK BARS, FORGED BARS etc.
 Stall No. : **Stall 80 / Hall 3**
 Company Name : **VIVEK STAINLESS (INDIA)**
 Address : 4, Motial Estate Near, Central Bank Kewal kantha Rakhial - 380023
 City : Ahmedabad
 Contact Person : Harish Patel
 Designation : (Sales Executive) at VIVEK STAINLESS INDIA in Rakhial
 Telephone No. : 9879791555
 Fax No. : 079 - 22742888,
 Cell No. : 079 - 22742888
 Email : hdpatel@vivekstainless.com
 Website : www.vivekstainless.com
 Business Type : Stainless Steel Pipe & Tube Manufactures/ Stockist Fittings & Plate
 Stall No. : **Stall 43 / Hall 3**
 Company Name : **WEVBERGER COATING I PVT. LTD**
 Address : JL 04, KANDUA POLY PARK, PO JAINAGAR, SANKRAIL
 City : DISTT: HOWRAH
 Contact Person : MR SOUMEN SINHA
 Designation : MANAGING DIRECTOR
 Telephone No. : 033-26615000
 Fax No. : 033-26615020
 Cell No. : 9830065945
 Email : soumen@grebe.in
 Website : www.grebe.com
 Brand Name : GREBLON
 Business Type : MANUFACTURER
 Products Details : NONSTICK COATING MATERIAL
 Stall No. : **Stall 59 / Hall 1**
 Company Name : **YASHWANT INDUSTRIES**
 Address : 440/7-A, G.I.D.C. NEAR NEPTUNE TEXTILE, ODHAV, AHMEDABAD
 City : AHMEDABAD
 Contact Person : MR. HIMANSHU MALVI
 Designation : BUSINESS
 Telephone No. : 22894423
 Cell No. : 8511125285
 Email : yashwantind1234@gmail.com
 Website : www.yashwantind.com
 Brand Name : MALVI
 Business Type : MANUFACTURERS
 Products Details : S.S. UTENSILS MACHINERY, SUBMERSIBLE MACHINERY, SOLAR TANK MACHINERY
 Stall No. : **Hall 2 / Stall 17**



Navtech innovative products of stainless steel have become a leisure pursuit in the recent years. **Navtech** produce a diversified range of inox articles termed as Cutlery, Kitchen Tools & Bar Tools etc. The products are crafted in a mix of indigenous & imported machinery with a very strict quality control like forming work, hardening, pressing, forging, edging & polishing. Whenever you see "**Navtech**" name, you can be sure that it means **QUALITY, STYLE, VALUE** - B'coz "**CUSTOMER FIRST**"

Navtech

Manufacturers & Suppliers of : S.S. Cutlery, Kitchen & Bar Tools
S-6, Badli Industrial Estate, Phase-1, Delhi - 110042 (INDIA)
Tel. : 27855691, 27853427 Fax : 27859112
Cell : 98111 44794, 9899104947, 9811058640
E-mail : sscutlery@rediffmail.com

इस अरबपति बिजनेसमैन ने अपने गांववालों को तोहफ में दिए लग्जरी फ्लैट

Multimillionaire Xiong Shuihua gifts luxury flats to 72 families



बजिंग। जिन झुग्गियों में खेलकर कभी यह अरबपति बिजनेसमैन बड़ा हुआ था, उन्हें ही तुड़वा कर इसने यहां लग्जरी फ्लैट बनवा दिए। यही नहीं इस व्यापारी ने यह सभी फ्लैट अपने उन्हीं गांववालों को तोहफे में दे दिए। साथ ही बुजुर्ग और गरीब गांववालों के लिए सप्ताह में तीन दिन मुफ्त खाने का भी इंतजाम किया है। चीन के स्टील किंग शियोंग शुईहुआ जिनयुई शहर के करीब एक गांव में 1955 में पैदा हुए थे। उनका परिवार बहुत गरीब था और इन्हीं गांववालों ने उस वक्त उनके परिवार की बहुत मदद की थी। तमाम मेहनत के बाद आज 54 वर्ष के शियोंग जब अमीर हो गए हैं तो उन्होंने अपने गांववालों की उदारता के बदले में उन्हें कुछ देने की सोची।

शियोंग की बदौलत यहां 72 परिवारों को लग्जरी फ्लैट मिले हैं और वह 18 परिवार जिन्होंने शियोंग के परिवार की बहुत मदद की थी उनके लिए उन्होंने विला बनवाए हैं। इस सब के लिए कुल 4 मिलियन पाउंड खर्च किए गए हैं। शियोंग कहते हैं, "मैंने इतना पैसा कमा लिया कि मुझे समझ ही नहीं आ रहा था कि इतने पैसे का क्या करूं। मैं अपनी जड़ें नहीं भूला था। मैंने हमेशा खुद को कर्जमुक्त रखा और मैं उन परिवारों का खुदपर सबसे बड़ा कर्ज भी उतारना चाहता था जो उन्होंने मेरे परिवार की मदद करके तब मुझपर चढ़ाया था जब मैं छोटा था।"

गांव में रहने वाले 75 वर्षीय कियॉन्ग चू ने बताया, "मैं शियोंग के माता पिता को जानता हूं। वे बहुत दयालू थे और दूसरों की बहुत परवाह किया करते थे। मुझे खुशी है कि उनका बेटा भी उनके जैसा ही दयालू है।"



Design And Technical Efficiency In The New Decorated 470li Stainless Steel Hood

Stainless steel is one of the most widely used materials in the production of hoods, since it is capable to meet all technical and aesthetical requirements. From a technical point of view, stainless steel ensures mechanical strength, resistance to even extremely high thermal loads, but above all, excellent resistance to corrosion phenomena. Products remain unchanged throughout their life cycle and require only few maintenance operations over time. Among the hoods included in the product range of this company, we find built-in, wall, and island hoods. One of the latest products is the "downdraft", a hood that can be considered both an in-built and an island hood. This product is the result of the combination of two materials - stainless steel and black tempered glass - that add to it a particular touch of modernity and elegance. For this new model of stainless steel hood, the company has chosen an innovative material, the superferritic 470LI (EN 1.4613) stainless steel, with a linen pattern finish, a premium material capable to stand heavy stresses and high temperatures, and to resist to corrosion, as the austenitic AISI 316 stainless steel. In addition, being a material with ferritic structure, it benefits from the advantage of price stability. The decorated linen pattern finish is obtained during the steel sheet cold-rolling process by means of special decorated rollers. The stainless steel sheet is subsequently submitted to a bright-annealing process.

Manufacturing company: Bs Service s.r.l. – NT AIR – Via G. Brodolini 77/a – I-60044 Fabriano AN, phone +39 0732 21008, +39 0732 251083, fax +39 0732

71469, staff@ntair.it, www.ntair.it / Stainless steel produced by: Acciai Speciali Terni S.p.A. – Viale B. Brin 218 – I-05100 Terni TR, phone +39 0744 490282,

fax +39 0744 490907, marketing.ast@acciaitermi.it, www acciaitermi.it

Source: Inossidabile 194



PARKASH



Largest Manufacturer of Best Quality Deep Drawing Presses in India



MECHANICAL CLUTCH
Deep Drawing
Presses

Hi-Rigidity

- Low-maintenance
- Good Metallurgy
- Noise-Less



PNEUMATIC CLUTCH
Deep Drawing
Presses

**Hand safety
curtain**

- Easy to operate

Introducing First Time In India CNC Zig-Zag Blanking Line (Fully Automatic)



Salient Features

- Zig-Zag decoiler (NC Hydraulic)
- Scrap chopper
- Fully CNC controlled panel
- Easy to Operate
- Less power consumption
- Less Space Requirement
- High Production
- Rigid "H" Type Ring Frame Press
- All Parts Oil Dip Running

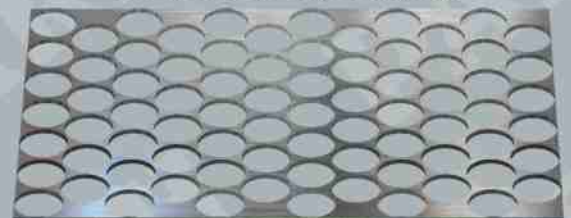

Find us on [YouTube](#) **Zigzag Blanking India**

SHARMA MACHINE TOOLS

(An ISO 9002 Company)

CB-164, Ring Road, Naraina, New Delhi-110028 (INDIA)
Tel.: +91-11-25778063, 25778220
E-mail : sharmapresses@gmail.com
Web. : www.smtparkash.in

Contact- Neeraj Sharma: +91-9811033616 Chandan Sharma: +91-9810550110



PARKASH



Introducing First Time in INDIA

Cutting - Turning - Beading Machine (Fully Automatic)



Salient Features

- ➔ **All Hydraulic Controls**
(No pneumatic / air connection required)
- ➔ **All Linear motion guide ways**
(No casting slide ways)
- ➔ **PLC & VFD Control panel**
(Easy & fast operation)
- ➔ **Two axis beading operation**
(Most suitable for draw bead components)
- ➔ **Skilled Labour not required for operation.**
- ➔ **Less space required**
- ➔ **Consistent Quality.**

Model No. CTB 450

Cutting - Turning - Beading Machine

SHARMA MACHINE TOOLS

(An ISO 9002 Company)

CB-164, Ring Road, Naraina, New Delhi-110028 (INDIA)
Tel.: +91-11-25778063, 25778220
E-mail : sharmapresses@gmail.com
Web : www.smtparkash.in

Contact- Neeraj Sharma: +91-9811033616 Chandan Sharma: +91-9810550110



TAJ[®]

the taste of *Elegance*
and purity for
your **PLEASURE**



Design By : Brennstoff Marcom
+91-9810742123

SOUP & JUICE STRAINERS | DISH COVERS | ATTA & MAIDA SIEVES | COLANDER & MESH BASKETS | TEA & COFFEE STRAINERS

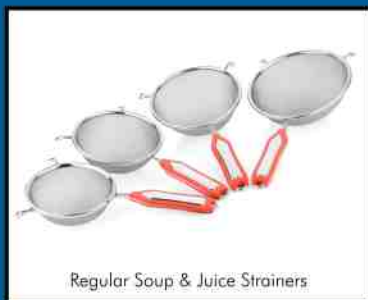

Regular Soup & Juice Strainers



Atta Sieves Four In One Interchange



Hand Free Tea & Coffee Strainer
Indian Double S.S Heavy Mesh
(Inner Twill Mesh)



Good Morning Tea & Coffee Strainer
Indian Double S.S Heavy Mesh
(Inner Twill Mesh)



S.S. Colander

Taj Kitchen Strainers brings to you a range of state-of-the-art products that has been innovated for premium choice in kitchen. As a brand we try to explore new designs and patterns that is reflected in our craftsmanship.

For any occasion our various products are remarkable to use as these are manufactured precisely for your pleasure. We have blended style with luxury through our products as it adds a class to your lifestyle.

So go on and associate with us by booking our products as you make more profits.

Taj Home craft Company
2117, Gali Ashok, B.G. Road, Delhi - 110006
Email : info@tajkitchenstrainers.in, tajhomecraft80@yahoo.com
For Distributor Enquiry
+91-9810196413, 9810144168, 9810134168, +91-11-65361031



Cert No. : QMS-8027



Cert No. : OHSAS 18001:2007



Cert No. : OHSAS 18001:2007

a stylish way...

Graphic⁹

website design | graphic design | printing solution

- Website Design with Platform
- Web / Cloud Application
- Exclusive Visiting Cards
- Exclusive Catalogue Design

Starting from
₹ 3,500 to ₹ 5 Lac

portfolio



www.steelmarketinfo.com
php, dynamic, India



www.pnbutensils.com
ralavel frame work, php 5.4, India



www.luckystainlesssteel.com
Responsive HTML, Jodhpur



www.groupsrm.com
Responsive HTML, Jodhpur



www.skyaircooler.com
HTML 5, Ahmedabad



www.graphic9.in/arrkaa
Own frame, India



www.greenharvest.in
Dynamic php, Jodhpur



www.chopraagro.com
Flash Static, Jodhpur



www.pradiplasto.com
Full Dynamic, php, Aurangabad

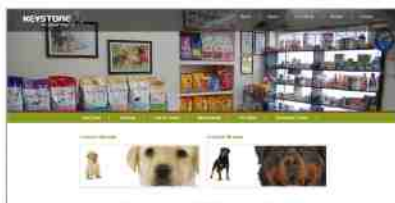

www.graphic9.in/keystone
Responsive HTML, Dynamic, Jodhpur



www.leyshaexim.com
Responsive HTML, Static, Germany



www.graphic9.in/flowerhandicraft
php static, France



contact us :

✉ 39-A, Pal Link Road, Shanti Priya Nagar,
Jodhpur - 342008, Rajasthan, INDIA

💬 skype: graphic-9
☎ +91-9799545692

✉ enquiry@graphic9.in
🌐 www.Graphic9.in

master chef
COLLECTION

MeeraTM
EXCLUSIVE

cooking, serving & gifting ripudaman handa's choice



NON STICK COOKING RANGE 3 MM



HARD ANODIZED MULTI KADAI



BUTTERFLY HANDI SET



DINNER SET 121 PCS

MEERA METAL INDUSTRIES :

134, GIDC Industrial Estate, Odhav, Ahmedabad, Gujrat - 383215 • Phone: 079-22890511, 22973734
Email: meerametalind@gmail.com • www.meeraexclusive.com • facebook: meeraexclusive



BHALARIA

if you can draw it, we can make it



- Beverage container
- Bakeware
- Barware
- Wire Products
- Stationery Products

- Tableware
- Bathroom accessories
- Houseware & Indian Houseware,
- Range in Tea, Desert, Spoon & Fork
- Kitchen Tools, tongs and Kitchen Gadgets

- Premium products available again
- Quality, Quantity in time
- 175 family Business
- A dependable company to work with

BHALARIA METAL CRAFT PVT. LTD.

Bhalaria Rd , Opp. Hindu Shmashan, Bhayander (W), Mumbai. Dist. Thane, Maharashtra 401 101, India Tel : (91-22) 2819 8234, 2819 8226, Fax : (91-22) 2819 8227, 2625 6526, E-mail : sale@bhalariametal.com, exports@bhalariametal.com, Website : www.bhalaria.com , www.bhalariametal.com



Always a class apart



Steels Pvt. Ltd.

Regd. Office: D/48, Sarvodaya nagar, Mahendra Kumar T. Road,
1st Panjarapole Lane, Mumbai - 400 004.

Tel : (022) 2242 5301, 2242 0429 Reliance : (022) 3257 7020 Fax : (022) 2242 1428

Factory: Atgaon Laghu Udhog Sankul, Mumbai Nasik Highway,
Village - Atgaon, Taluka - Shahpur, District - Thane - 421 601.

Email : milisteel@vsnl.net; info@milisteel.com
www.milisteel.com

Since 1984



Shri & Sam
for Better Homes

Cutlery
Kitchenware
Hotelware
Holloware
Barware
Gifts & Promotion

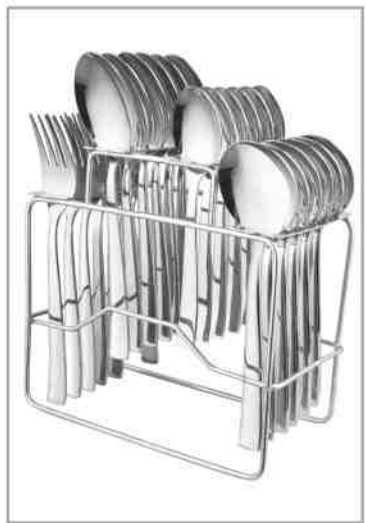
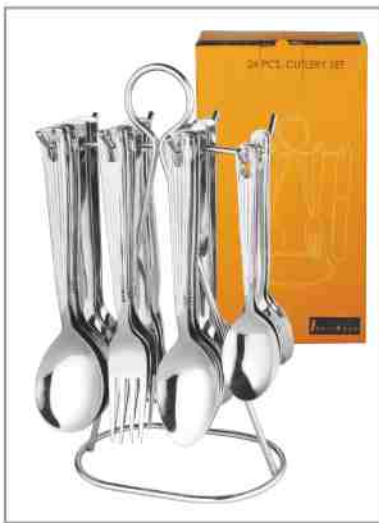

OUR MAJOR INDIAN BUSINESS ASSOCIATES



Pawan Kansal (MD)

National Award Winner

in export excellence and quality products in the year 2005. Award winner from 8 consecutive year since 2006 for the highest growth in exports from ministry of commerce & steel and the irrespsective council.

Jagdamba^{eli}
CUTLERY PVT. LTD.

JAGDAMBA CUTLERY PVT.LTD.
Factory / Show Room: Plot No.: 153 I&J&D,
HSIDC Ind. Area EPIP Kundli, Haryana - 131028, INDIA
Website - www.jagdambafatware.com,
Email : India@jagdambafatware.com,
Contact Numbers -
Tel.: +91 130 2374453 , 2374454, 2374455, 2374456;
Fax: +91 130 2374452 (Sales)
Mobile no. : +91 9811178827 (Mr. Pawan Kansal)
+91 9711985677 (Mr. Tushar Singh Gautam)



**5th INDIAN
Stainless Steel
Houseware Show**

**12 13 14
JULY 2015**

**Chennai Trade Center
CHENNAI, INDIA**

**SAVE THE DATE
BOOK YOUR STALL**

www.inoxhousewareshow.com

EXHIBITION PRODUCT CATEGORIES

- Utensils
- Cookware
- Kitchenware
- Kitchen tool & Cutlery
- Machinery & Accessories
- Tableware
- Petware
- Gift Items
- Raw Materials
- Restaurant & Hotel ware



Organized & Promoted by:

Steel Market Info

THE MAGAZINE DEVOTED TO STAINLESS STEEL AND ITS APPLICATIONS **स्टील मार्केट इन्फो**

2nd Floor, Nirmal Tower, Chopasani Road, JODHPUR - 342 003 (Raj.) INDIA
Ph.: 0291-2441514, 2632533 • Mob.: +91-773-773-1015, 9314713809
Email: event@steelmarketinfo.com • Web: www.steelmarketinfo.com

